

180 PIPE ADJUSTER
PART # D0WPVS180S
QTY: _____

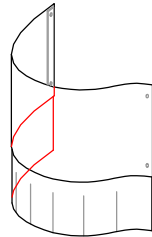

180 UPPER HINGE SEAL
PART # D0MGS180HS
QTY: _____

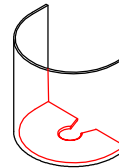

180 SOLID RISER
PART # D05PP180CT
QTY: _____



180 V-CAM ASSEMBLY

- PART # D05PP180LC (LEFT) QTY: _____
- PART # D05AS18HOL (L HO) QTY: _____
- PART # D05PP180RC (RIGHT) QTY: _____
- PART # D05AS18HOR (R HO) QTY: _____



- ROLLER ASSEMBLY**
- PART # D05AS5508C (Std.) QTY: _____
- PART # D05AS5508S (SS) QTY: _____

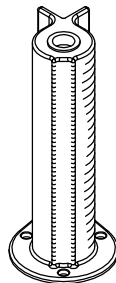

LOWER HINGE GUARD
PART # D05AL18LHC
QTY: _____



"NOSING"
PVC Gasket Retainer for Back and Bottom Edges of Panel (102" Long)
PART # D05PP0908E
QTY: _____

1/8" Poly, Frame & Fasteners (Front & Back - Single Pane)

Size	Part Number	Qty
8" x 14"	D05KT0814W	
12" x 18"	D0MPK01218	
16" x 16"	D0MPK01616	
17" x 23"	D0MPK01723	

1/8" Poly, Frame & Fasteners (Front & Back - Double Pane)

Size	Part Number	Qty
8" x 14"	Not Available	
12" x 18"	D0MPK1218D	
16" x 16"	D0MPK1616D	
17" x 23"	D0MPK1723D	

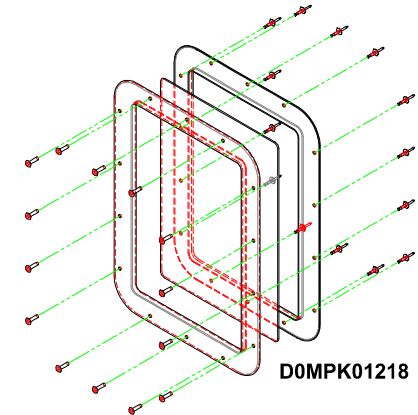

D0MPK01218

ADA APPROVED WINDOW KITS

1/8" Poly, Frame & Fasteners (Front & Back - Single Pane ONLY)

Size	Part Number	Qty
10" x 30" ADA	D05KT1030A	
12" x 30" ADA	D05KT1230A	
16" x 30" ADA	D05KT1630A	
20" x 30" ADA	D05KT2030A	
24" x 30" ADA	D05KT2430A	

RETAILER GASKETS*

90° X 180° Hardware Only

Part Number	Durus #	Qty
D05GS01628	1628	
D0MGS00719	1535	
D05GS1680A	1680	
D05GS01182	1613	
D0MGS00870	1560	
D0MGS00686	1558	
D05GS1682C	1682	
D0NAS180SW		

*Standard Gaskets in Bold

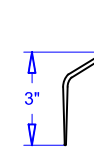

TOP SEAL
OPENING WIDTH: _____
SPACE BETWEEN HEADER & TOP OF DOOR: _____
QTY: _____
DURUS PART # 1580 (Std. 2"-3")
DURUS PART # 1580E (> 3")



D05GS01628
1628
(STD Leading Edge Single)

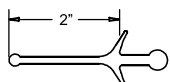

D0MGS00719
1535
(STD Leading Edge Double)

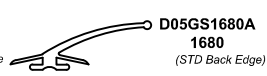

D05GS1680A
1680
(STD Back Edge)

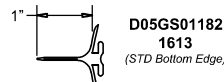

D05GS01182
1613
(STD Bottom Edge)

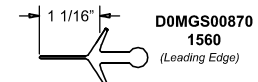

D0MGS00870
1560
(Leading Edge)

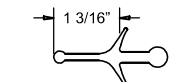

D0MGS00686
1558
(Leading Edge)

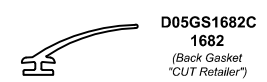

D05GS1682C
1682
(Back Gasket "CUT Retailer")



D0NAS180SW
(Lower Hinge Sweep)

RETAILER GASKETS

DURULITE® RETAILER
90° X 180° Hardware Only

PART REPLACEMENT ORDER FORM

Chase Doors
World's Leading Manufacturer Of Traffic Doors
Cincinnati, OH and Redmond, OR
Phone Toll Free: 1-800-543-4455
E-Mail: csred@chasedoors.com