

ADJUSTABLE HINGE GUARD
"Aluminum ONLY"
PART # D05KTADJLH
QTY: _____

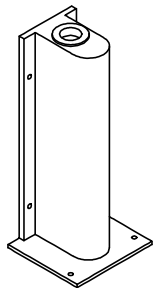

LOWER HINGE GUARD
"Aluminum"
PART # D05ASHGRCT
QTY: _____

LOWER HINGE GUARD
"Stainless Steel"
PART # D05AS9090C
QTY: _____

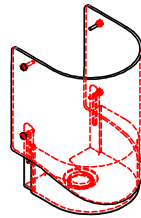

"NEW STYLE"
UPPER HINGE SEAL
PART # D05KTHS008 (KIT)
PART # D05PPHSRAP (SEAL)
QTY: _____

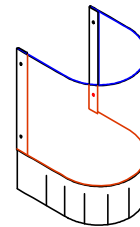

"OLD STYLE"
UPPER HINGE SEAL
PART # D0MGS0014
QTY: _____

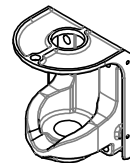

UPPER "V-CAM" HINGE ASSEMBLY
("One Piece" Full Composite)
PART # D05AS55290
QTY: _____

(With "HOLD OPEN" Option)
PART # D05ASRETHO
QTY: _____



"V-CAM"
(For Extended Opening Heights)
PART # D05CSRVCPC
QTY: _____



"NOSING"
PVC Gasket Retainer for Back and Bottom Edges of Panel (102" Long)
PART # D05PP0908E
QTY: _____



ROLLER ASSEMBLY
PART # D05AS5508C
QTY: _____

ROLLER ASSEMBLY w/
Stainless Steel Bearing
PART # D05AS5508S
QTY: _____

1/8" Poly, Frame & Fasteners (Front & Back - Single Pane)

Size	Part Number	Qty
8" x 14"	D05KT0814W	
12" x 18"	D0MPK01218	
16" x 16"	D0MPK01616	
17" x 23"	D0MPK01723	

1/8" Poly, Frame & Fasteners (Front & Back - Double Pane)

Size	Part Number	Qty
8" x 14"	Not Available	
12" x 18"	D0MPK1218D	
16" x 16"	D0MPK1616D	
17" x 23"	D0MPK1723D	

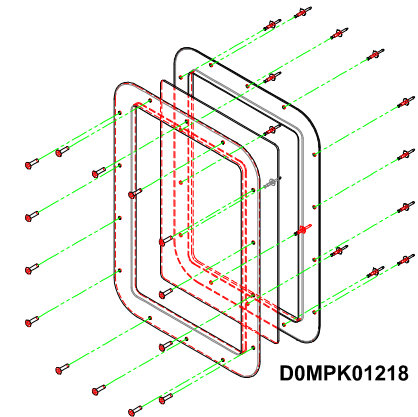

D0MPK01218

ADA APPROVED WINDOW KITS

1/8" Poly, Frame & Fasteners (Front & Back - Single Pane ONLY)

Size	Part Number	Qty
10" x 30" ADA	D05KT1030A	
12" x 30" ADA	D05KT1230A	
16" x 30" ADA	D05KT1630A	
20" x 30" ADA	D05KT2030A	
24" x 30" ADA	D05KT2430A	



TOP SEAL
OPENING WIDTH: _____
SPACE BETWEEN HEADER
& TOP OF DOOR: _____
QTY: _____
DURUS PART # 1520 (Std. 2")
DURUS PART # 1520E (> 2")

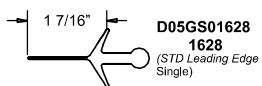

D05GS01628
1628
(STD Leading Edge Single)



D0MGS00719
1535
(STD Leading Edge Double)

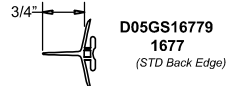

D05GS16779
1677
(STD Back Edge)

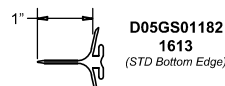

D05GS01182
1613
(STD Bottom Edge)

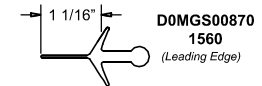

D0MGS00870
1560
(Leading Edge)

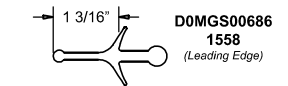

D0MGS00686
1558
(Leading Edge)

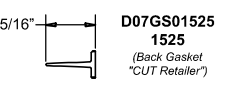

D07GS01525
1525
(Back Gasket "CUT Retailer")

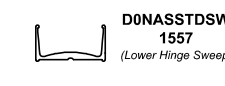

D0NASSTD5W
1557
(Lower Hinge Sweep)

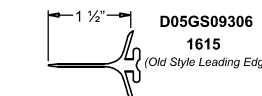

D05GS09306
1615
(Old Style Leading Edge)

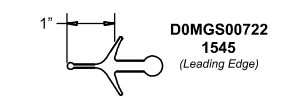

D0MGS00722
1545
(Leading Edge)

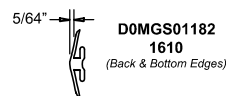

D0MGS01182
1610
(Back & Bottom Edges)

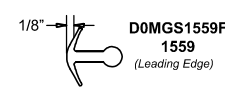

D0MGS1559F
1559
(Leading Edge)

RETAILER GASKETS*
90° X 90° Hardware Only

Part Number	Durus #	Qty
D05GS01628	1628	
D0MGS00719	1535	
D05GS16779	1677	
D05GS01182	1613	
D0MGS00870	1560	
D0MGS00686	1558	
D07GS01525	1525	
D0NASSTD5W	1557	
D05GS09306	1615	
D0MGS00722	1545	
D0MGS01182	1610	
D0MGS1559F	1559	

*Standard Gaskets in Bold

DURULITE® RETAILER
90° X 90° Hardware Only

PART REPLACEMENT ORDER FORM

Chase Doors
World's Leading Manufacturer Of Traffic Doors
Cincinnati, OH and Redmond, OR
Phone Toll Free: 1-800-543-4455
E-Mail: csred@chasedoors.com