

DuraShield Installation Manual

Chain Hoist – Inside Standoff – Da-lite Springtube

CHAIN HOIST INSIDE STANDOFF GENERAL MOUNTING DIAGRAM

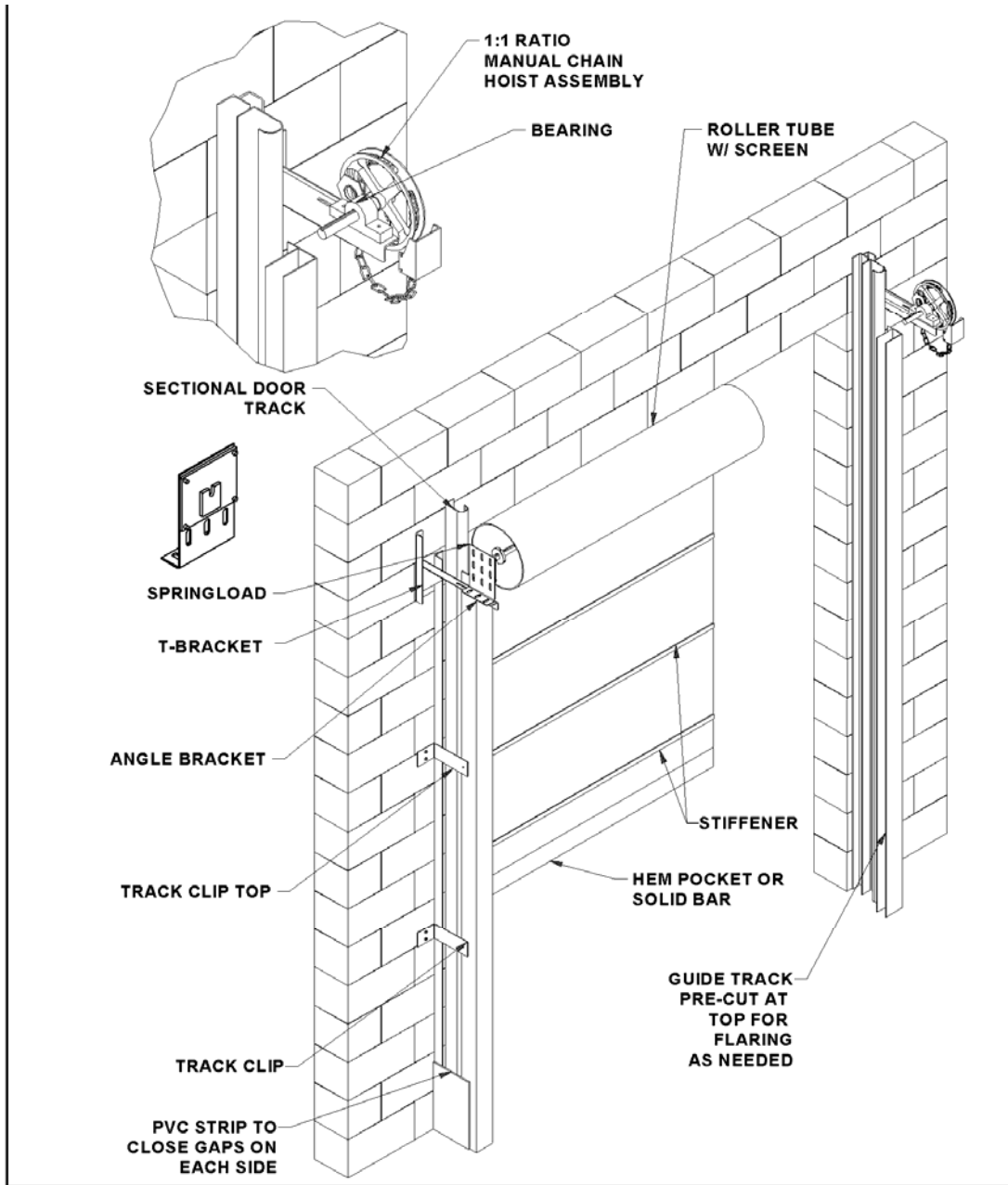

DuraShield Installation Manual

Chain Hoist – Inside Standoff – Da-lite Springtube

INSIDE STANDOFF MOUNTING EXAMPLES

1. TOP OF DOOR OPENING
2. TOP OF FLAT SURFACE OF "I" BRACKET

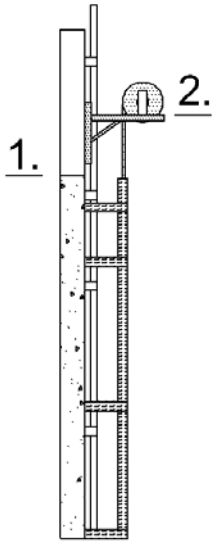

A) FULL VERTICAL LIFT

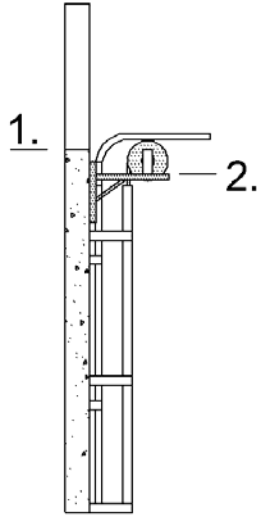

B) STD. LIFT/ LOW HEADROOM 15 INCH RADIUS DOOR

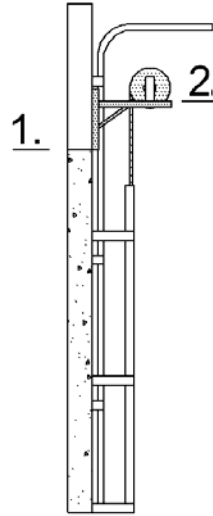

C) HIGH LIFT

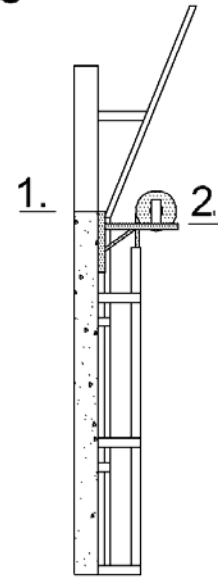

D) VERTICAL LIFT BREAKAWAY (SITS WITHIN DOOR OPENING)

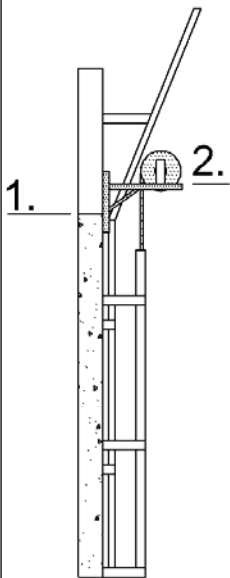

E) VERTICAL LIFT BREAKAWAY (SITS ABOVE DOOR OPENING)

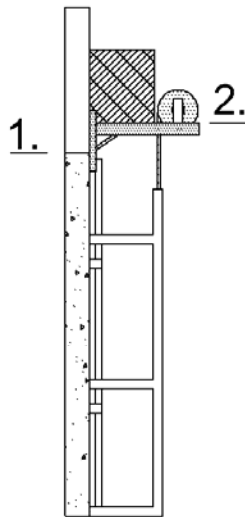

F) COILING STEEL (SITS IN FRONT OF COILING STEEL BOX ABOVE DOOR OPENING)

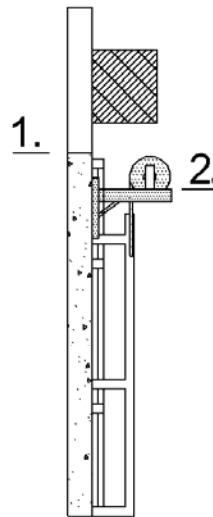

G) COILING STEEL (SITS BELOW COILING STEEL BOX - WITHIN DOOR OPENING)

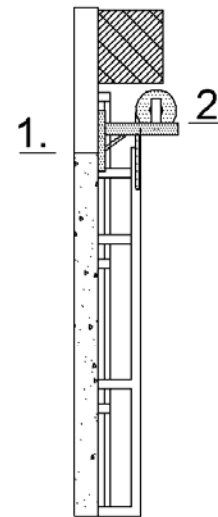

H) COILING STEEL (SITS BELOW COILING STEEL BOX - WITHIN DOOR OPENING)

DuraShield Installation Manual

Chain Hoist – Inside Standoff – Da-lite Springtube

1. Wall preparation – refer to following drawing

Note and understand the clear opening width and height dimensions of the purchased door before proceeding with the installation.

The door must be securely mounted to a smooth surface. If necessary, based on the wall construction, a metal plate would be installed to the wall as a mounting surface for the T Brackets (by installer). Typically a 12" x 12" plate would be needed.

The door, of course, needs to be mounted so that the head and roll are level and square. The guide tracks must also be square and level in relation to the header, the wall and each other.

Failure to properly secure, level and square the door components during installation may result in premature wear and failure of components which will not be covered by manufacturer warranty.

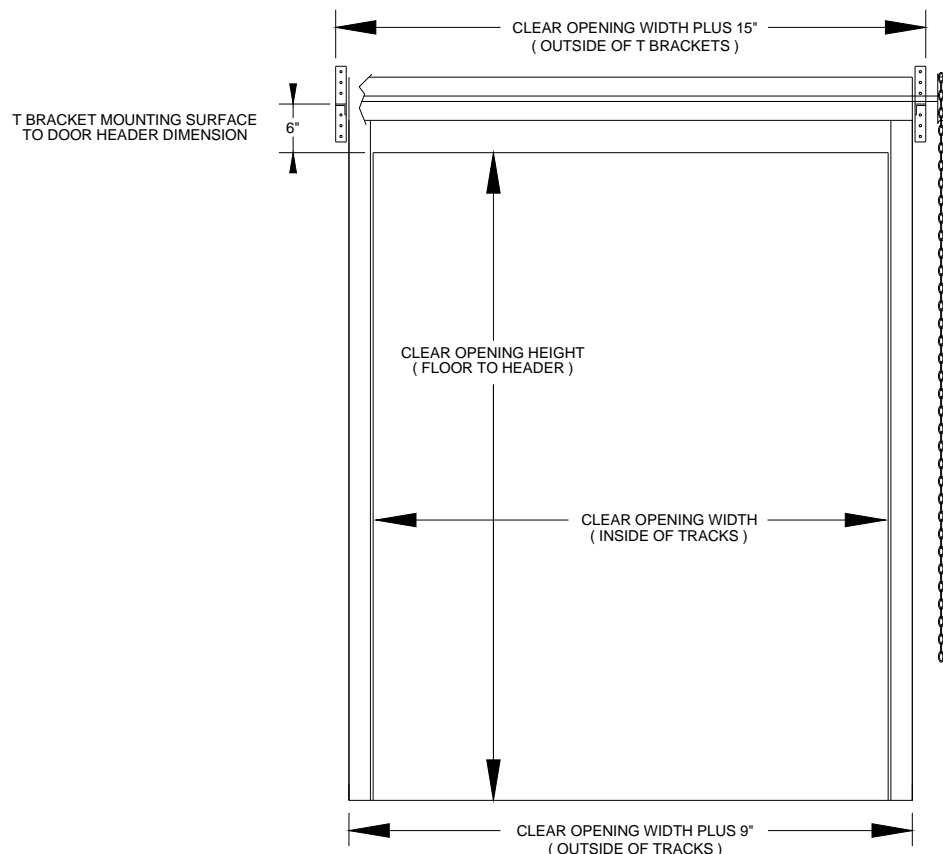

Door dimension drawing

DuraShield Installation Manual

Chain Hoist – Inside Standoff – Da-lite Springtube

2. T Bracket Installation

refer to Door Mounting and Dimension Drawings on page 2 & 3

Referring to the door size and following drawing, locate and mount the T Brackets using appropriate fasteners for the wall surface. The T Bracket bearing mounting surface should be located to be at minimum 6" above the door header as shown. The inside mounting dimension of the T Brackets is Clear Opening Width + 11 inches, centered on the opening.

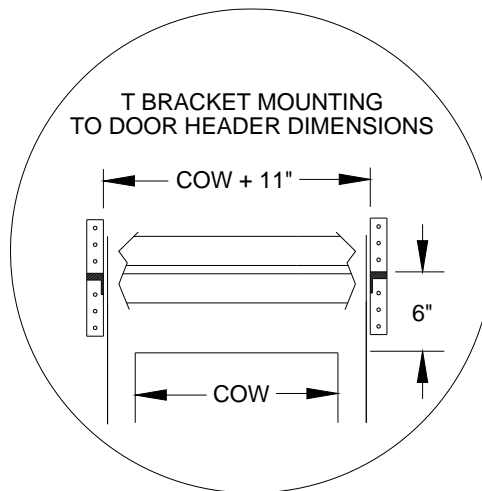

Right side shown, Left side opposite

DuraShield Installation Manual

Chain Hoist – Inside Standoff – Da-lite Springtube

3. Roll Installation - NOTE: If you have a Roll Cover with Roll Cover Brackets provided see section 9 for installation before installing the Roll

On the idler side of the door mount the L Bracket onto the T Bracket. The Cradle bracket is factory mounted onto the L Bracket. Tighten the T bracket bolts but leave loose enough for later adjustment. Be sure the curtain is coming off of the back of the roll.

On the chain hoist side of the door slide the pillow block bearing with locking collar onto the shaft.

Lift the roll into position. The square drive spring end will sit into the matching Cradle Bracket slot on the idler side.

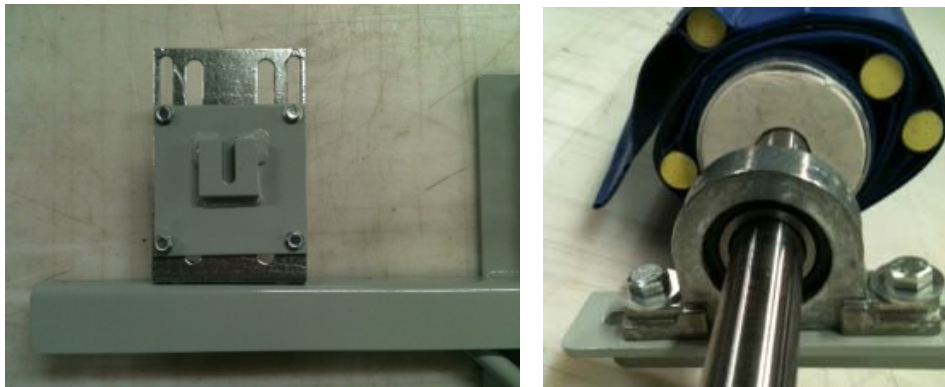

Put the pillow block onto the T Bracket on the chain hoist side and mount it to the T Bracket. Tighten the T bracket bolts but leave loose enough for later adjustment. Once the bearing is mounted tighten the locking collar set screws. **DO NOT REMOVE CURTAIN STRAPS YET!** Install and tighten the shaft set screws on the Cradle Bracket.

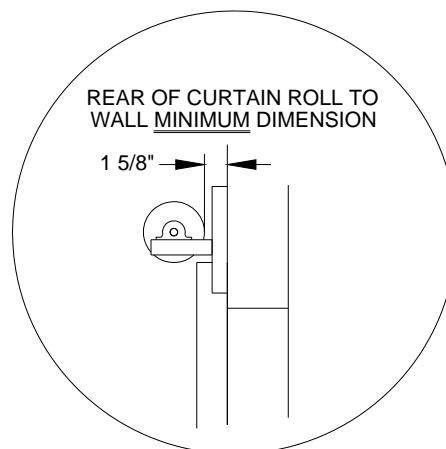

DuraShield Installation Manual

Chain Hoist – Inside Standoff – Da-lite Springtube

4. Chain Hoist Installation

Install the set collar, chain guard, keyed chain hoist wheel and second set collar onto the extended shaft. Tighten the set screws securely. Install the chain around the wheel. Chain can be cut to desired length and a coupling chain link is provided. Install the wall mount chain stop at a convenient height.

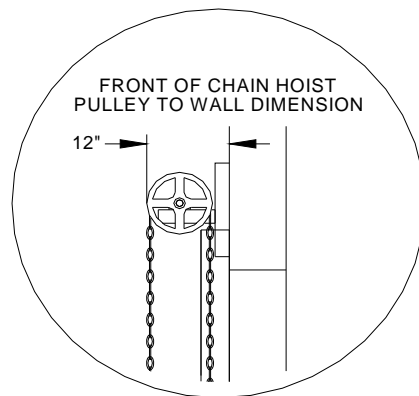

Chain hoist showing Chain Stop and Stop block installed

5. Installation of Guide Tracks - refer to Door Mounting and Dimension Drawings on page 2 & 3

Measure the Guide Tracks provided as they may need to be cut on site during installation. Be sure to cut the bottom of the track if needed. The top of the guide tracks should be 2 inches minimum to 3 inches maximum from the fully opened curtain roll.

The Guide Tracks are slotted on one end. This is the top. The rear of the Guide Track should be mounted to the wall using Guide Track L Brackets using a two foot spacing. Tracks are mounted to the floor using two Guide Track L Brackets if desired.

The slotted tabs on the top of the track are bent outward at an angle. Bend the rear until it reaches the wall and bend the front to approximately the same angle. Insert the end of the curtain into the track.

DuraShield Installation Manual

Chain Hoist – Inside Standoff – Da-lite Springtube



Extended Guide Track Mounting Bracket



Top Track Adjustment

6. Setting Counterbalance spring tension and door position

The curtain straps must still be in place to tension the spring.



Using the chain hoist, roll the tube as though closing the door for 10 revolutions of the roll. With the door in the open position latch the hoist chain to the chain stop.

Install the Stop Block mechanism on the chain as shown on page 5. Position it so that the door will not roll up higher than the Clear Opening Height. Leave the curtain in the fully opened position.

DuraShield Installation Manual

Chain Hoist – Inside Standoff – Da-lite Springtube

Remove the curtain straps. Operate the door closed and opened several times to allow the curtain to seat itself on the roll tube.

When closing note that closing too far will allow excess material to gather on the floor and may cause premature wear on the material on the bottom of the curtain. Close the door and latch the hoist chain to the chain stop.

If the spring tension needs adjustment now or at any point after this the curtain must be rolled up and the curtain straps reinstalled. Then the spring tension can be adjusted as was previously done.

7. Confirm adjustment of roll clearance in Guide Tracks -

Be sure that both ends of the roll on the T Brackets maintain entry of the curtain into the Guide Tracks at the curtain positions as shown below and to the minimum dimension shown on page 4. Fully tighten all roll mounting bolts. It could be necessary to drill additional holes in the T Brackets to properly adjust the roll to wall clearance.

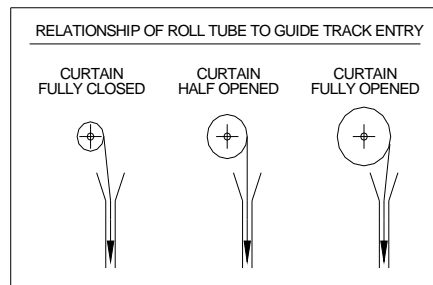

DuraShield Installation Manual

Chain Hoist – Inside Standoff – Da-lite Springtube

8. Installation of Optional Header Brush Seals -

Install the OPTIONAL curtain brush seal by attaching it to the bottom of the external door as shown. (fasteners not included) It can also mount to another surface as shown. The installer should determine an appropriate location. Be sure that the brush seal contacts the curtain when in the full closed position but does not press so hard to deform the curtain. Install the Top Side Brush Seals, the seals are field fit. Mark holes in seal mounting strip to mount on the (2) 3/8" L Bracket mounting bolts with provided fasteners as shown. The brush will contact the curtain and roll.

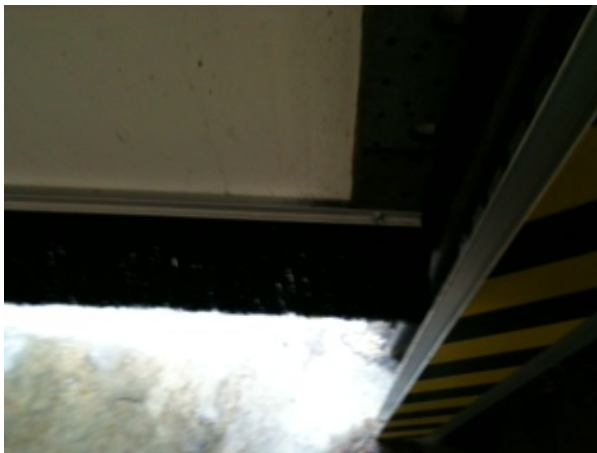

Brush seal mounted on bottom face of door



Top side brush seal and fasteners

9. Installation of Optional Roll Cover -

Center the roll cover over the roll. Fasten securely to the wall.



DuraShield Installation Manual

Chain Hoist – Inside Standoff – Da-lite Springtube

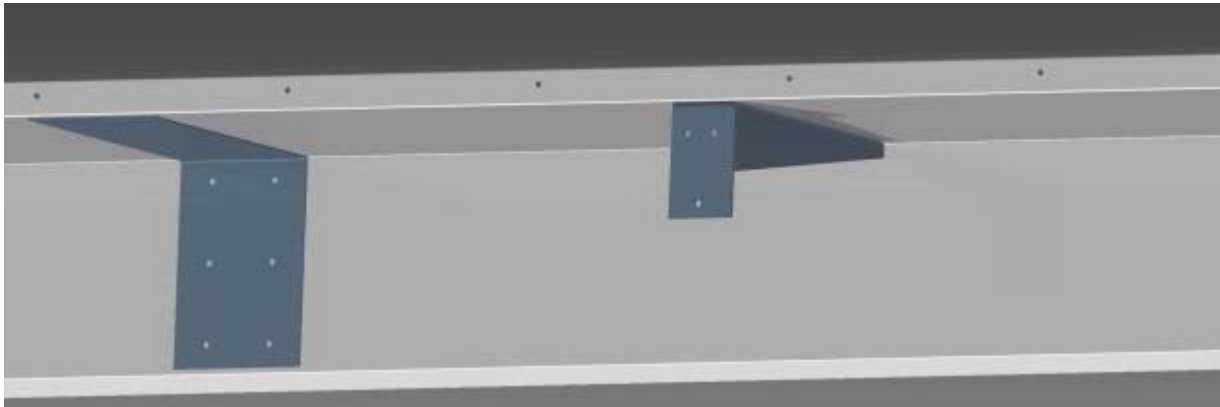

Splice Plate

Roll Cover Bracket

If your Roll Cover comes in multiple pieces a Splice Plate is provided, as shown, to connect the Roll Cover sections together. On wider Roll Covers, support brackets are provided as shown. The Roll Cover Brackets should be mounted to the wall to support the weight of the Roll Cover. They would be installed prior to installing the Roll as in section 3. They should be mounted so that the Roll Cover will be level when installed. They should be mounted near each end of the Roll Cover location and then spaced at approximately 24” apart. The Roll Cover is then lifted onto the installed support brackets and secured to the wall as normal. The Roll Cover does not attach to the support brackets, just to the wall. Any openings in the end caps, for shafts etc., are to be done by the installer on site.

10. Final Assembly -

Go back and recheck all fasteners on the door assembly for tightness

Confirm correct opening and closing positions as well as spring tension

Confirm curtain to guide track clearances per section 7. Be sure that guide tracks are clean and grease free inside and out.

Install Black Vinyl (PVC) side panels (if supplied). These panels close in the gap between the Guide Track and the wall, see diagram on page 1. The side panel attaches to the Guide Track with installed Velcro and the installer attaches it to the wall in an appropriate manner

Make sure end user is familiar with operation and has all manuals

DuraShield Installation Manual

Chain Hoist – Inside Standoff – Da-lite Springtube