

DuraShield Installation Manual

In Tube Motor- Somfy – Inside Standoff

SOMFY IN-TUBE MOTOR INSIDE STANDOFF GENERAL MOUNTING DIAGRAM

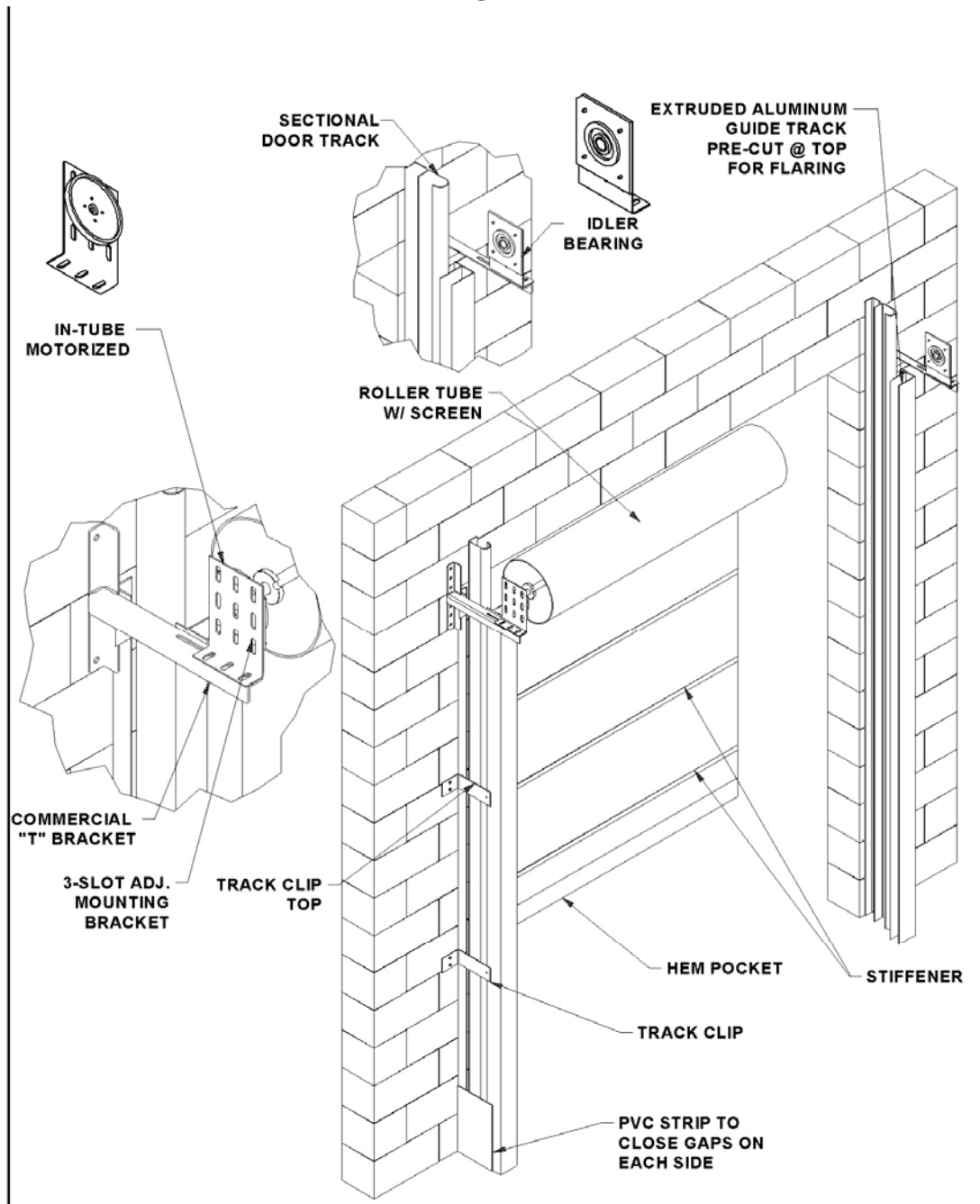

DuraShield Installation Manual

In Tube Motor- Somfy – Inside Standoff

INSIDE STANDOFF MOUNTING EXAMPLES

1. TOP OF DOOR OPENING
2. TOP OF FLAT SURFACE OF "I" BRACKET

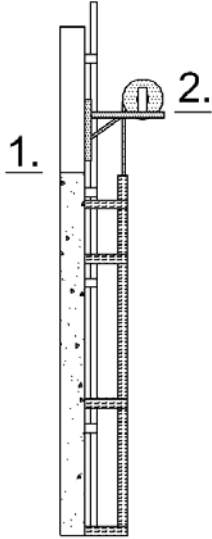

A) FULL VERTICAL LIFT

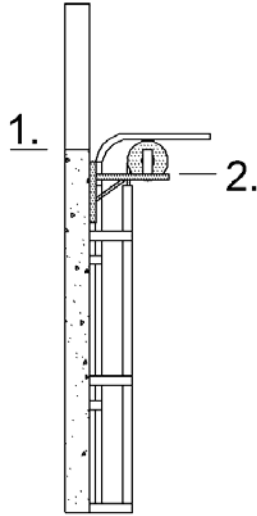

B) STD. LIFT/ LOW HEADROOM 15 INCH RADIUS DOOR

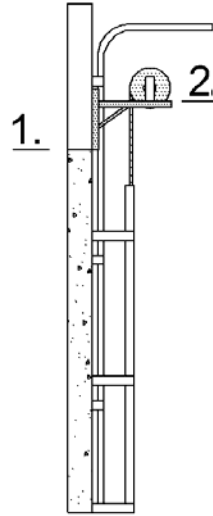

C) HIGH LIFT

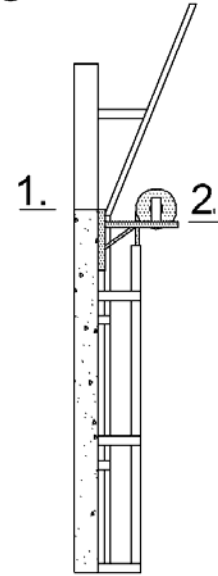

D) VERTICAL LIFT BREAKAWAY (SITS WITHIN DOOR OPENING)

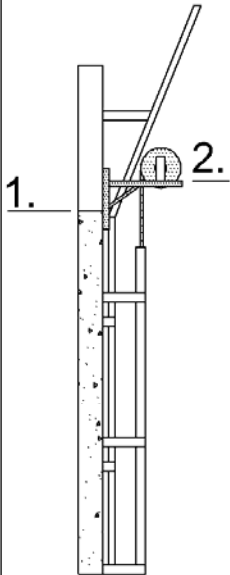

E) VERTICAL LIFT BREAKAWAY (SITS ABOVE DOOR OPENING)

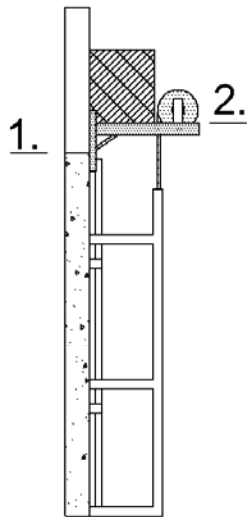

F) COILING STEEL (SITS IN FRONT OF COILING STEEL BOX ABOVE DOOR OPENING)

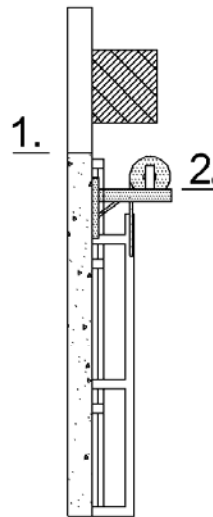

G) COILING STEEL (SITS BELOW COILING STEEL BOX - WITHIN DOOR OPENING)

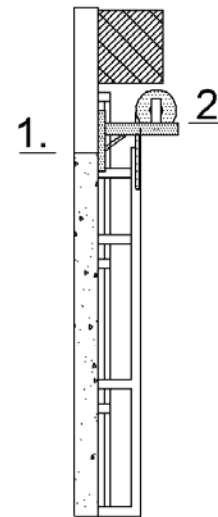

H) COILING STEEL (SITS BELOW COILING STEEL BOX - WITHIN DOOR OPENING)

DuraShield Installation Manual

In Tube Motor- Somfy – Inside Standoff

1. Wall preparation – refer to following drawing

Note and understand the clear opening width and height dimensions of the purchased door before proceeding with the installation.

The door must be securely mounted to a smooth surface. If necessary, based on the wall construction, a metal plate would be installed to the wall as a mounting surface for the T Brackets (by installer). Typically a 12" x 12" plate would be needed.

The door, of course, needs to be mounted so that the head and roll are level and square. The guide tracks must also be square and level in relation to the header, the wall and each other.

Failure to properly secure, level and square the door components during installation may result in premature wear and failure of components which will not be covered by manufacturer warranty.

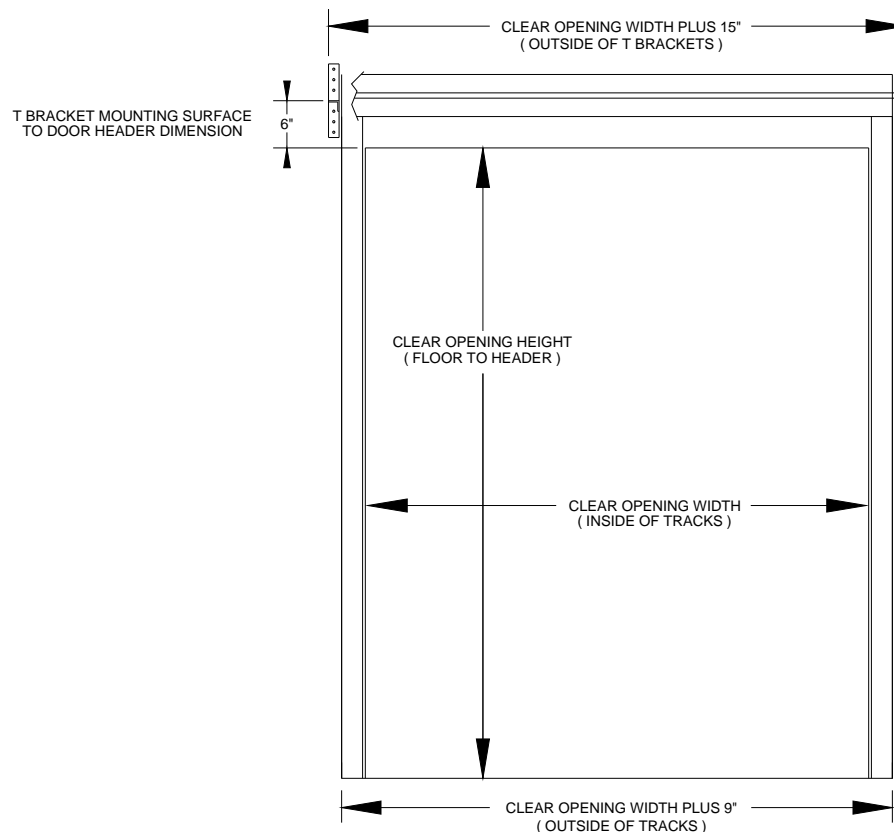

Door dimension drawing

DuraShield Installation Manual

In Tube Motor- Somfy – Inside Standoff

2. T Bracket Installation

refer to Door Mounting and Dimension Drawings on page 2 & 3

Referring to the door size and following drawing, locate and mount the T Brackets using appropriate fasteners for the wall surface. The T Bracket bearing mounting surface should be located to be at minimum 6" above the door header as shown. The inside mounting dimension of the T Brackets is Clear Opening Width + 11 inches, centered on the opening.

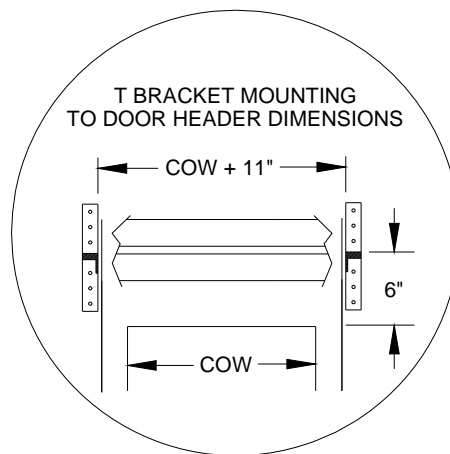

Right side shown, Left side opposite

DuraShield Installation Manual

In Tube Motor- Somfy – Inside Standoff

3. Roll Installation - NOTE: If you have a Roll Cover with Roll Cover Brackets provided see section 9 for installation before installing the Roll

On both sides of the door, mount the L Brackets onto the T Brackets. The Bearing Bracket and Mounting Ring are factory mounted onto the L Brackets. Tighten the L bracket bolts but leave loose enough for later adjustment. Be sure the curtain is coming off of the back of the roll. Lift the roll into position. Insert the spring end into the bearing.

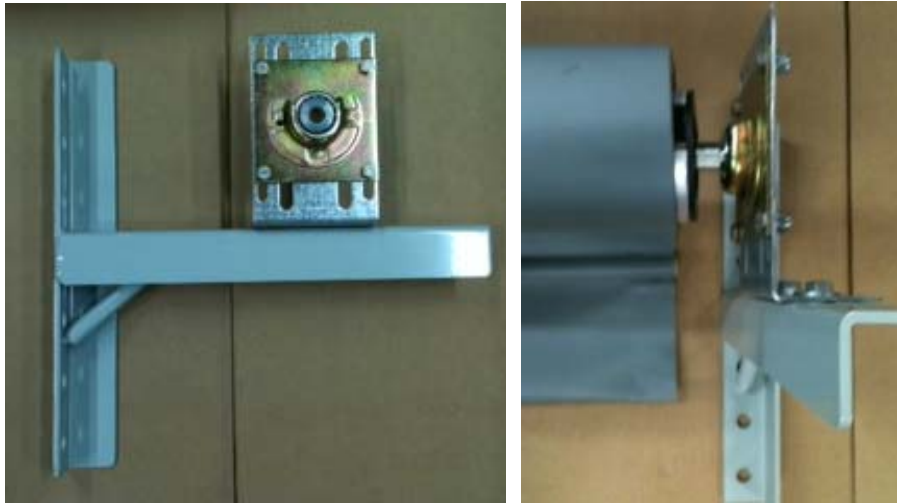

Lift the drive end of the roll into position. Be sure the limit switch adjustment buttons are facing up and that the cord exit position will not cause interference with operation of the roll.

Push the roll towards the bearing end which will compress the spring and allow the installation of the roll into the mounting ring. Push the roll into the mounting ring until the snap spring is fully engaged.



DuraShield Installation Manual

In Tube Motor- Somfy – Inside Standoff

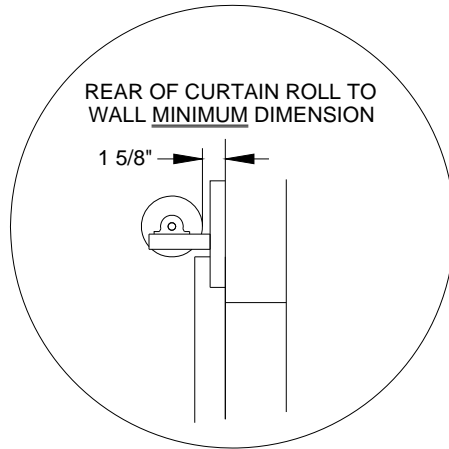

Exploded view of motorized side



Exploded view of bearing side

DuraShield Installation Manual

In Tube Motor- Somfy – Inside Standoff

4. Installation of Guide Tracks - refer to Door Mounting and Dimension Drawings on page 2 & 3

Measure the Guide Tracks provided as they may need to be cut on site during installation. Be sure to cut the bottom of the track if needed. The top of the guide tracks should be 2 inches minimum to 3 inches maximum from the fully opened curtain roll.

The Guide Tracks are slotted on one end. This is the top. The rear of the Guide Track should be flat against the wall surface and are mounted to the wall using Guide Track L Brackets using a two foot spacing. Tracks are mounted to the floor using two Guide Track L Brackets if desired.

The slotted tabs on the top of the track are bent outward at an angle. Bend the rear until it reaches the wall and bend the front to approximately the same angle. Insert the end of the curtain into the track.

Mount the 3 button station on the wall beside the track on the drive side of the door.



Extended Guide Track Mounting Bracket



Top Track Adjustment

DuraShield Installation Manual

In Tube Motor- Somfy – Inside Standoff

5. Adjustment of Limit Switches – Somfy motor only

Be sure the curtain is coming off the back of the roll towards the wall.

Plug in the supplied power cord from the 3 button station to a 120 VAC power source

Remove the Yellow Limit Switch Cover. Press both limit switch buttons to the locked down position. Press and hold the Close Pushbutton. If the door is not rotating in the same direction as the pushbutton indicates refer to page 8 to reverse motor rotation and for limit switch identification. When the curtain is close to the fully closed position release the Close Pushbutton to stop the door and press the closed limit switch so that it releases to the raised position. This sets the closed position. When closed the door should only contact the floor enough to seal. Closing too far will cause premature wear of the curtain material.

Repeat using the Open Pushbutton and the opened limit switch for the fully opened position. When fully opened the bottom of the curtain should be no higher than the door header.

When done, cycle the door by opening and closing several times to seat the curtain on the roll. At this time make final limit switch adjustments if needed and replace the limit switch adjustment button cover.



Limit switch adjustment buttons. Cover shown removed.

NOTE: The motor is not rated for continuous usage. There is a built in Thermal Overload device that limits continuous usage to approximately 5 minutes. If tripped, the overload device will allow motor operation once the motor has cooled to an acceptable operational temperature.

DuraShield Installation Manual

In Tube Motor- Somfy – Inside Standoff

6. Confirm adjustment of roll clearance in Guide Tracks -

Be sure that both ends of the roll on the T Brackets maintain entry of the curtain into the Guide Tracks at the curtain positions as shown below and to the minimum dimension shown on page 4. Fully tighten all roll mounting bolts. It could be necessary to drill additional holes in the T Brackets to properly adjust the roll to wall clearance.

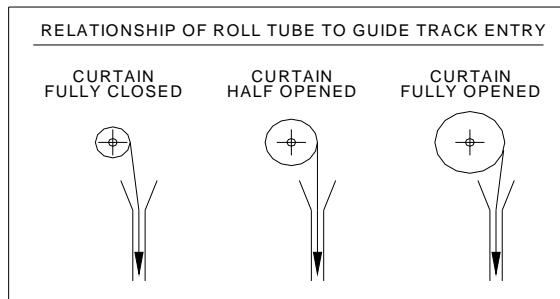

7. Pushbutton Station wiring -

The 3 button pushbutton station comes pre-wired for connection to a 120 VAC power source. To change the motor rotation, usually because the pushbuttons are operating the door in the opposite direction than required, remove power from the 3 button station and switch the Red and Black wires on the open and close pushbutton terminals. Be sure the curtain is coming off the back of the roll towards the wall before changing rotation direction.

Left hand motor – Open = Red wire (yellow limit), Closed = Black wire (white limit)
Right hand motor – Open = Black wire (white limit), Closed = Red wire (yellow limit)



DuraShield Installation Manual

In Tube Motor- Somfy – Inside Standoff

8. Installation of Optional Header Brush Seals -

Install the OPTIONAL curtain brush seal by attaching it to the bottom of the external door as shown. (fasteners not included) It can also mount to another surface as shown. The installer should determine an appropriate location. Be sure that the brush seal contacts the curtain when in the full closed position but does not press so hard to deform the curtain. Install the Top Side Brush Seals, the seals are field fit. Mark holes in seal mounting strip to mount on the (2) 3/8" L Bracket mounting bolts with provided fasteners as shown. The brush will contact the curtain and roll.

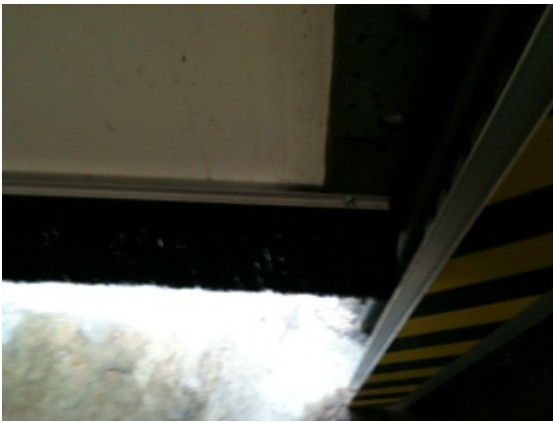

Brush seal mounted on bottom face of door



Top side brush seal and fasteners

9. Installation of Optional Roll Cover -

Center the roll cover over the roll. Fasten securely to the wall.



DuraShield Installation Manual

In Tube Motor- Somfy – Inside Standoff

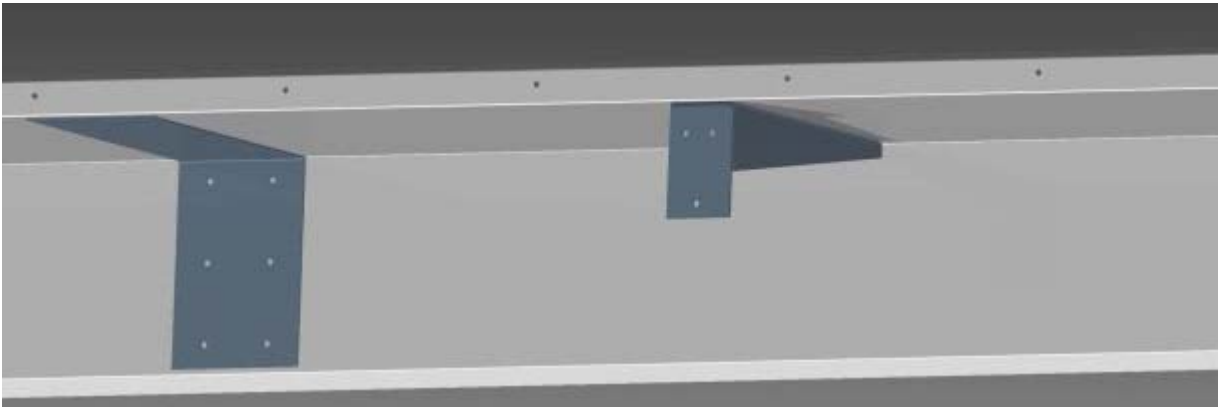

Splice Plate

Roll Cover Bracket

If your Roll Cover comes in multiple pieces a Splice Plate is provided, as shown, to connect the Roll Cover sections together. On wider Roll Covers, support brackets are provided as shown. The Roll Cover Brackets should be mounted to the wall to support the weight of the Roll Cover. They would be installed prior to installing the Roll as in section 3. They should be mounted so that the Roll Cover will be level when installed. They should be mounted near each end of the Roll Cover location and then spaced at approximately 24” apart. The Roll Cover is then lifted onto the installed support brackets and secured to the wall as normal. The Roll Cover does not attach to the support brackets, just to the wall.

10. Final Assembly -

Go back and recheck all fasteners on the door assembly for tightness

Confirm correct opening and closing positions. Reset limit switches if needed.

Confirm curtain to guide track clearances per section 6. Be sure that guide tracks are clean and grease free inside and out.

Install Black Vinyl side panels (if supplied). These panels close in the gap between the Guide Track and the wall, see diagram on page 1. The side panel attaches to the Guide Track with installed Velcro and the installer attaches it to the wall in an appropriate manner.

Make sure end user is familiar with operation and has all manuals

DuraShield Installation Manual

In Tube Motor- Somfy – Inside Standoff