

# DuraShield Installation Manual

## Springload – Face of Wall – Da-lite Springtube

SPRINGLOAD FACE OF WALL GENERAL MOUNTING DIAGRAM

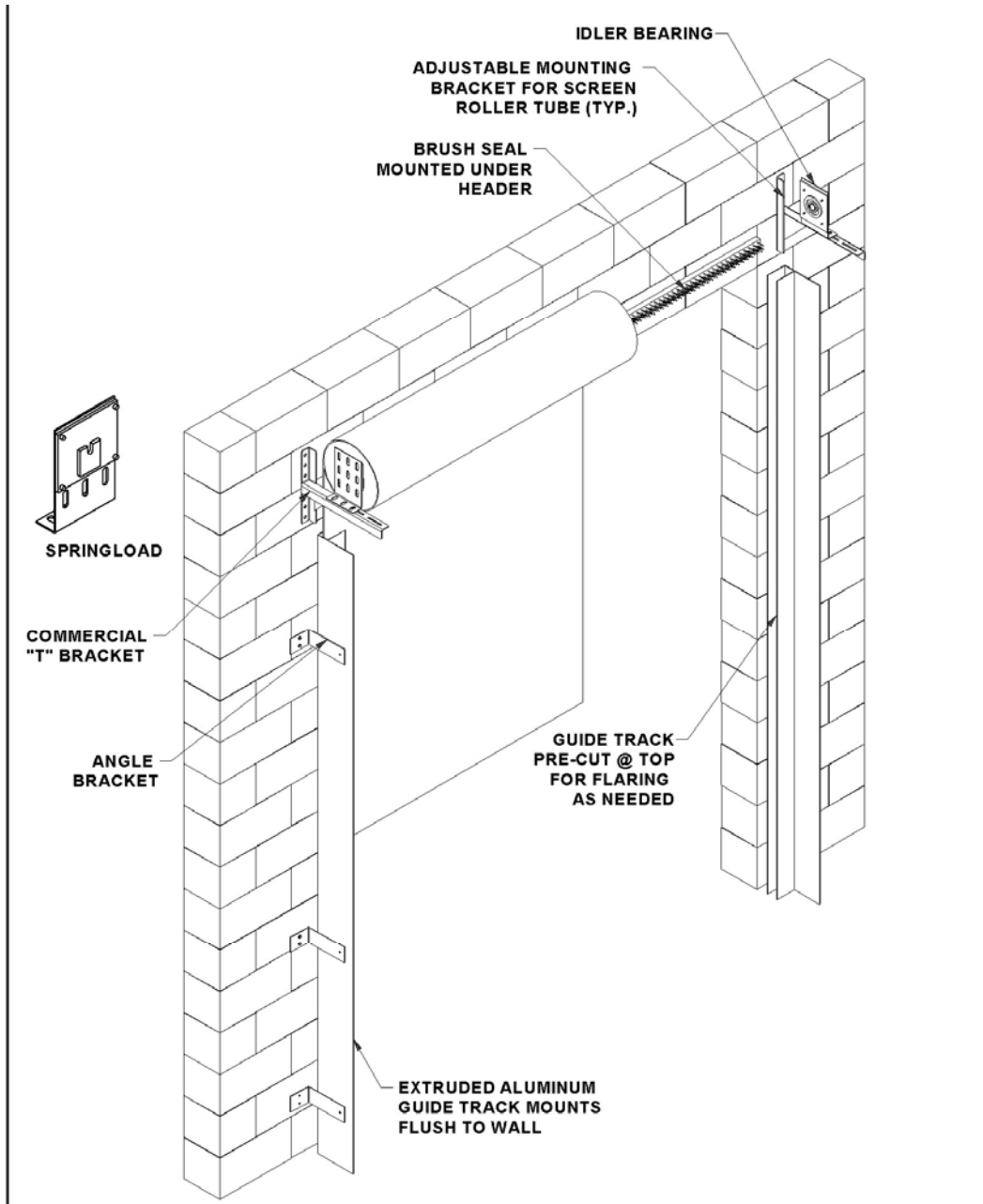

# DuraShield Installation Manual

## Springload – Face of Wall – Da-lite Springtube

### 1. Wall preparation – refer to following drawing

Note and understand the clear opening width and height dimensions of the purchased door before proceeding with the installation.

The door must be securely mounted to a smooth surface. If necessary, based on the wall construction, a metal plate would be installed to the wall as a mounting surface for the T Brackets (by installer). Typically a 12" x 12" plate would be needed.

The door, of course, needs to be mounted so that the head and roll are level and square. The guide tracks must also be square and level in relation to the header, the wall and each other.

Failure to properly secure, level and square the door components during installation may result in premature wear and failure of components which will not be covered by manufacturer warranty.

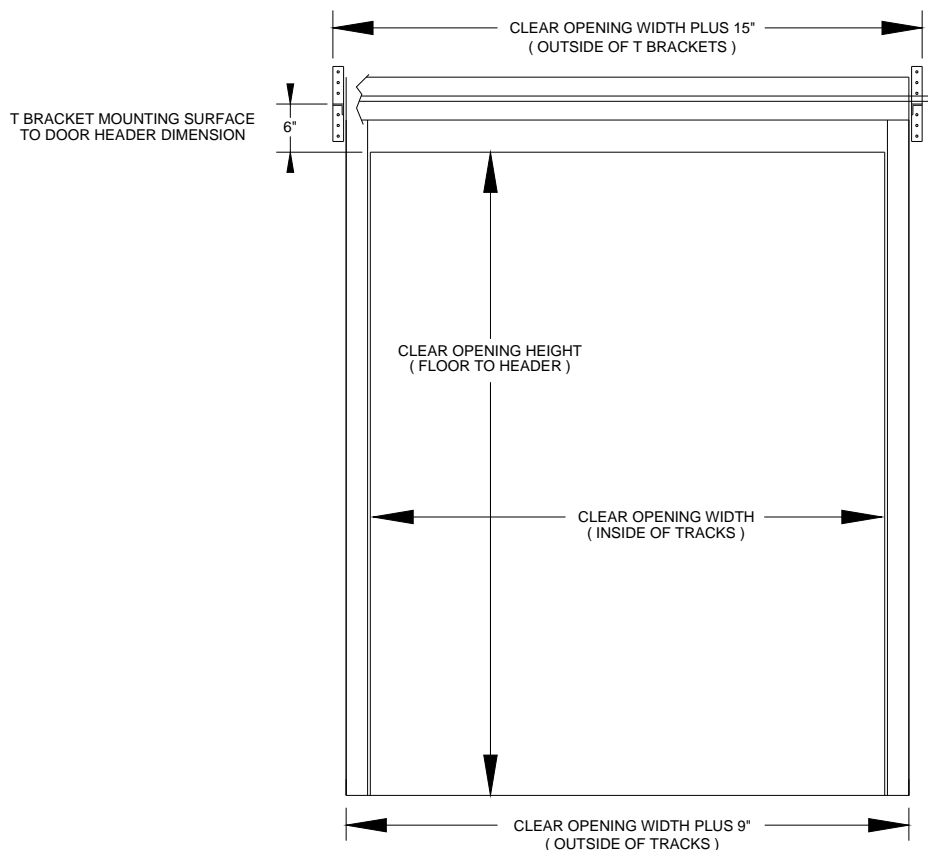

**Door dimension drawing**

# DuraShield Installation Manual

## Springload – Face of Wall – Da-lite Springtube

### 2. T Bracket Installation

Referring to the door size and following drawing, locate and mount the T Brackets using appropriate fasteners for the wall surface. The T Bracket bearing mounting surface should be located to be at minimum 6" above the door header as shown. The inside mounting dimension of the T Brackets is Clear Opening Width + 11 inches, centered on the opening.

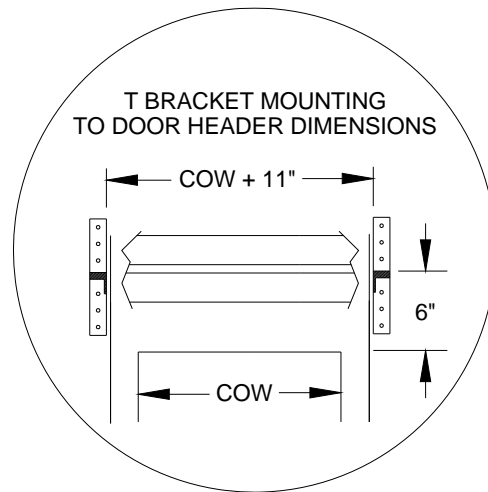

Right side shown, Left side opposite

# DuraShield Installation Manual

## Springload – Face of Wall – Da-lite Springtube

### 3. Roll Installation - NOTE: If you have a Roll Cover with Roll Cover Brackets provided see section 8 for installation before installing the Roll

On both sides of the door, mount the L Brackets onto the T Brackets.  
The Bearing Bracket and Cradle Bracket are factory mounted onto the L Brackets. Tighten the L bracket bolts but leave loose enough for later adjustment.  
Be sure the curtain is coming off of the back of the roll.  
Lift the roll into position. Insert the spring end into the bearing.

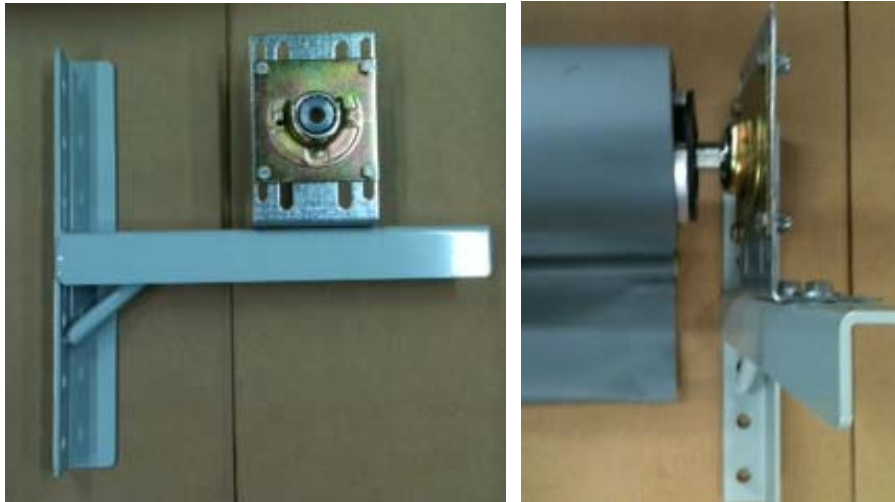

Insert the Counterbalance Spring end of the roll into the Cradle Bracket. Do not tighten the set screws yet.



**DO NOT UNTIE THE ROLLOVER STRAPS YET!**

# DuraShield Installation Manual

## Springload – Face of Wall – Da-lite Springtube

### 4. Installation of Guide Tracks - refer to Door Dimension Drawing on page 2

Measure the Guide Tracks provided as they may need to be cut on site during installation. Be sure to cut the bottom of the track if needed. The top of the guide tracks should be 2 inches minimum to 3 inches maximum from the fully opened curtain roll.

The Guide Tracks are slotted on one end. This is the top. The rear of the Guide Track should be flat against the wall surface and are mounted to the wall using Guide Track L Brackets using a two foot spacing. Tracks are mounted to the floor using two Guide Track L Brackets if desired.

The slotted tabs on the top of the track are bent outward at an angle. Bend the rear until it reaches the wall and bend the front to approximately the same angle.



Guide Track Mounting Bracket



Top Track Adjustment

# DuraShield Installation Manual

## Springload – Face of Wall – Da-lite Springtube

### 5. Setting Counterbalance Spring tension and door position

The Rollover Straps must still be tied in place on the roll to tension the Counterbalance Spring.



Rollover Straps tied around roll



Rollover Strap Bracket with strap and Hitch Pin on Guide Track

While maintaining pressure on the roll against the Spring End Bearing lift the Counterbalance Spring end of the roll out of the Cradle Bracket. Using the Winding Handle, preload the Counterbalance Spring by winding clockwise putting 34 turns on it. This is an estimated starting tension. Final tension adjustment depends on door size and curtain weight. With the Winding Handle still in place reinsert the Counterbalance Spring end of the roll into the Cradle Bracket and while holding the Rollover Straps, so the curtain roll will not wind up, remove the Winding Handle.



Winding Handle Placement

**Use care as the Counterbalance Spring is under tension and will unwind quickly if the Winding handle falls off or is let loose**

Untie the curtain Rollover Straps and connect them to the Rollover Strap Brackets that are installed about halfway up on the Guide Tracks. Pull the door fully closed. Mark and drill the Guide Tracks so that the two Hitch Pins will go through the grommets in the curtain to hold the door in the fully closed position.

# DuraShield Installation Manual

## Springload – Face of Wall – Da-lite Springtube

### Setting Counterbalance Spring tension and door position continued -

Attach the Hitch Pin cables to the Guide track so they reach the hole you previously drilled for it in the Guide Track.

**DO NOT ATTACH SO ANY FASTENER EXTENDS INTO THE GUIDE TRACK WHERE IT CAN COME INTO CONTACT WITH THE CURTAIN.**

Open and close the door several times to allow the curtain to seat itself on the roll tube. The tension on the Counterbalance Spring should be balanced so that the door will open smoothly without running away while opening and be slightly tensioned while closing.

When closing note that closing too far will allow excess material to gather on the floor and may cause premature wear on the material on the bottom of the curtain. Adjust the Curtain Rollover Strap tension so that the straps are tight when the door is in the fully opened position.

### 6. Confirm adjustment of roll clearance in Guide Tracks -

Be sure that both ends of the roll on the T Brackets maintain entry of the curtain into the Guide Tracks at the curtain positions as shown below and to the minimum wall clearance dimension as shown. Fully tighten all roll mounting bolts. It could be necessary to drill additional holes in the T Brackets to properly adjust the roll to wall clearance.

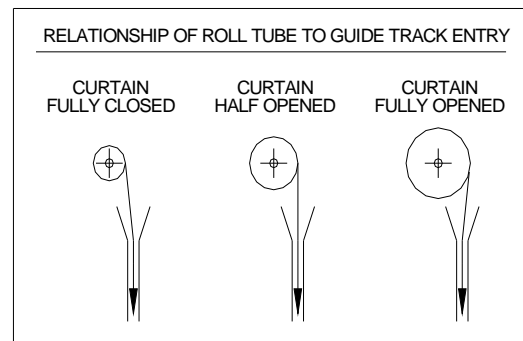
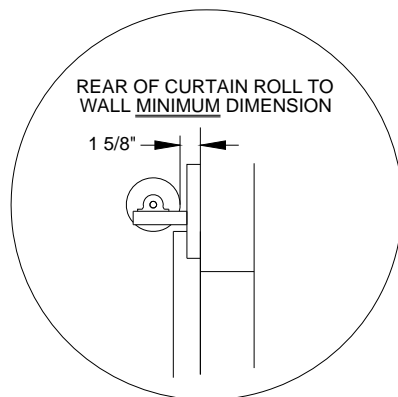

If the Counterbalance Spring tension needs adjustment now, or at any point after this, the curtain must be rolled up, the Rollover Straps disconnected and tied around the curtain roll. Then the Counterbalance Spring tension can be adjusted as was previously done.

Tighten the Shaft Set Screws on the Cradle Bracket.

# DuraShield Installation Manual

## Springload – Face of Wall – Da-lite Springtube

### 7. Installation of Optional Header Brush Seal -

Install the curtain Brush Seal by attaching it to the bottom of the header as shown. Header fasteners are not included. Be sure that the brush seal contacts the curtain when in the full closed position but does not press so hard to deform the curtain.

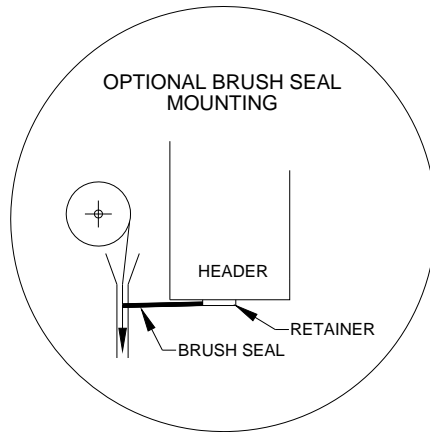

View looking up at door header



# DuraShield Installation Manual

## Springload – Face of Wall – Da-lite Springtube

### 8. Installation of Optional Roll Cover -

Center the roll cover over the roll. Fasten securely to the wall.

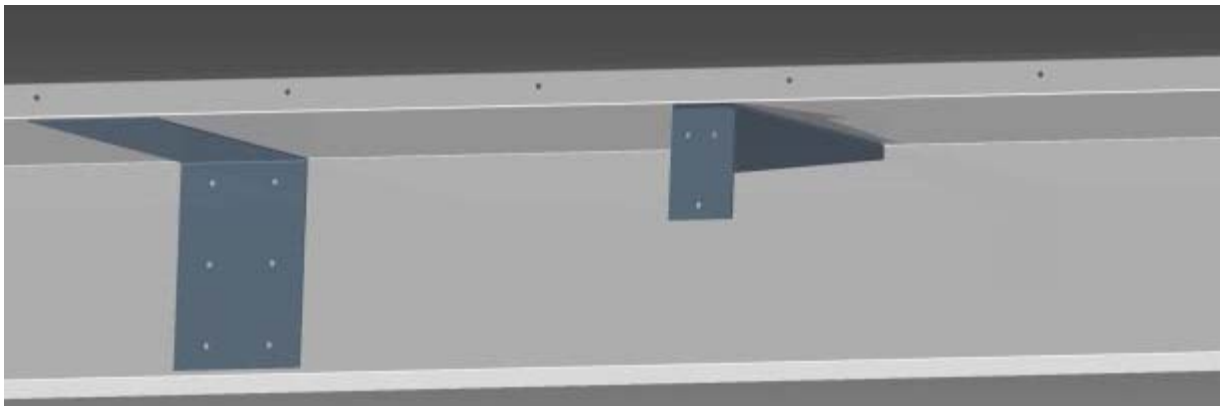

Splice Plate

Roll Cover Bracket

If your Roll Cover comes in multiple pieces a Splice Plate is provided, as shown, to connect the Roll Cover sections together. On wider Roll Covers, support brackets are provided as shown. The Roll Cover Brackets should be mounted to the wall to support the weight of the Roll Cover. They would be installed prior to installing the Roll as in section 3. They should be mounted so that the Roll Cover will be level when installed. They should be mounted near each end of the Roll Cover location and then spaced at approximately 24” apart. The Roll Cover is then lifted onto the installed support brackets and secured to the wall as normal. The Roll Cover does not attach to the support brackets, just to the wall.

# DuraShield Installation Manual

## Springload – Face of Wall – Da-lite Springtube

### 9. Final Assembly -

Go back and recheck all fasteners on the door assembly for tightness

Confirm correct opening and closing positions as well as spring tension

Confirm curtain to guide track clearances per section 6. Be sure that guide tracks are clean and grease free inside and out.

Make sure end user is familiar with operation and has all manuals

# **DuraShield Installation Manual**

Springload – Face of Wall – Da-lite Springtube