

DuraShield Installation Manual

Motorized – Inside Standoff

MOTORIZED INSIDE STANDOFF GENERAL MOUNTING DIAGRAM

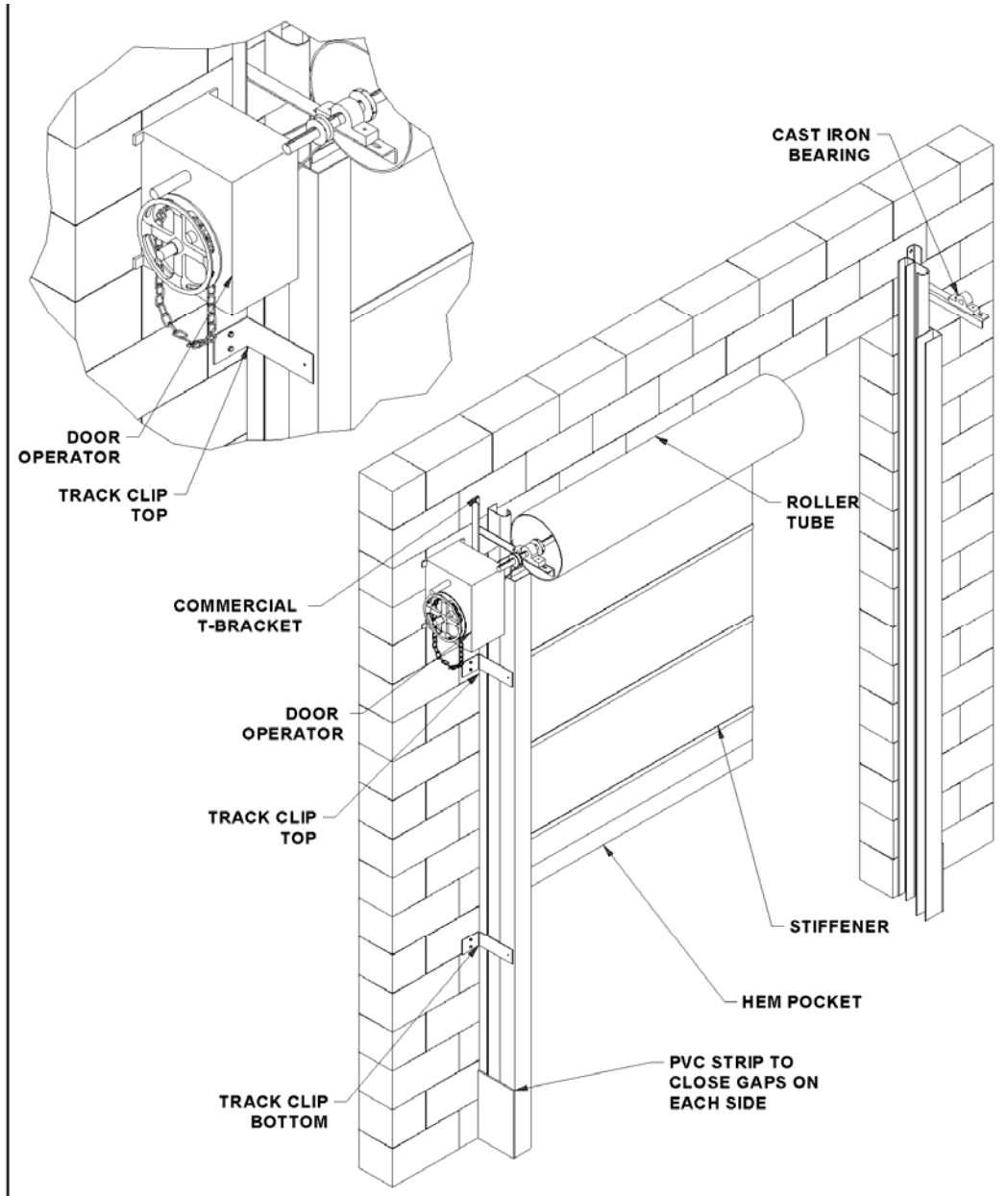

DuraShield Installation Manual

Motorized – Inside Standoff

INSIDE STANDOFF MOUNTING EXAMPLES

1. TOP OF DOOR OPENING
2. TOP OF FLAT SURFACE OF "I" BRACKET

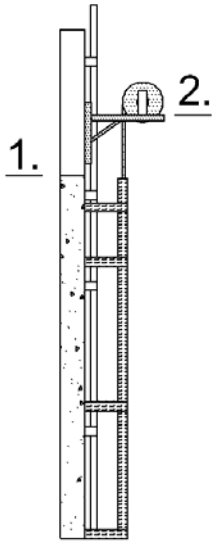

A) FULL VERTICAL LIFT

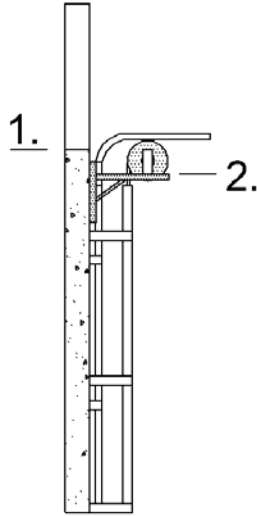

B) STD. LIFT/ LOW HEADROOM 15 INCH RADIUS DOOR

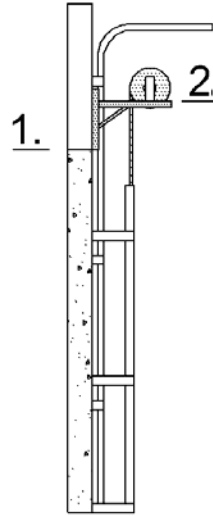

C) HIGH LIFT

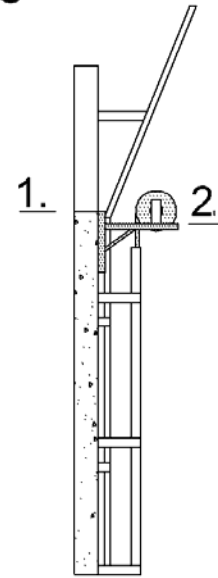

D) VERTICAL LIFT BREAKAWAY (SITS WITHIN DOOR OPENING)

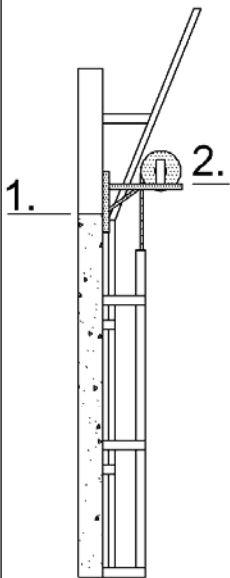

E) VERTICAL LIFT BREAKAWAY (SITS ABOVE DOOR OPENING)

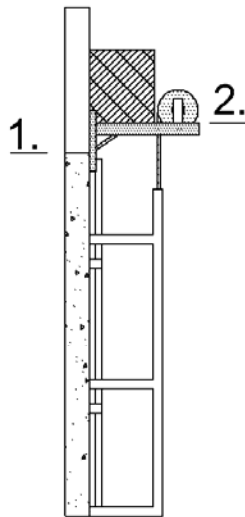

F) COILING STEEL (SITS IN FRONT OF COILING STEEL BOX ABOVE DOOR OPENING)

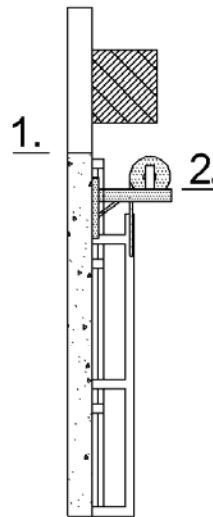

G) COILING STEEL (SITS BELOW COILING STEEL BOX - WITHIN DOOR OPENING)

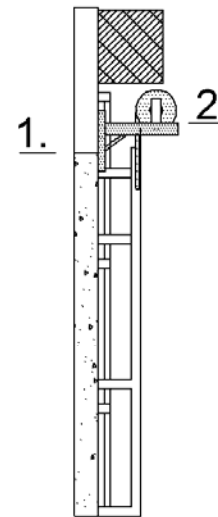

H) COILING STEEL (SITS BELOW COILING STEEL BOX - WITHIN DOOR OPENING)

DuraShield Installation Manual

Motorized – Inside Standoff

1. Wall preparation – refer to following drawing

Note and understand the clear opening width and height dimensions of the purchased door before proceeding with the installation.

The door must be securely mounted to a smooth surface. If necessary, based on the wall construction, a metal plate would be installed to the wall as a mounting surface for the T Brackets (by installer). Typically a 12" x 12" plate would be needed.

The door, of course, needs to be mounted so that the head and roll are level and square. The guide tracks must also be square and level in relation to the header, the wall and each other.

Failure to properly secure, level and square the door components during installation may result in premature wear and failure of components which will not be covered by manufacturer warranty.

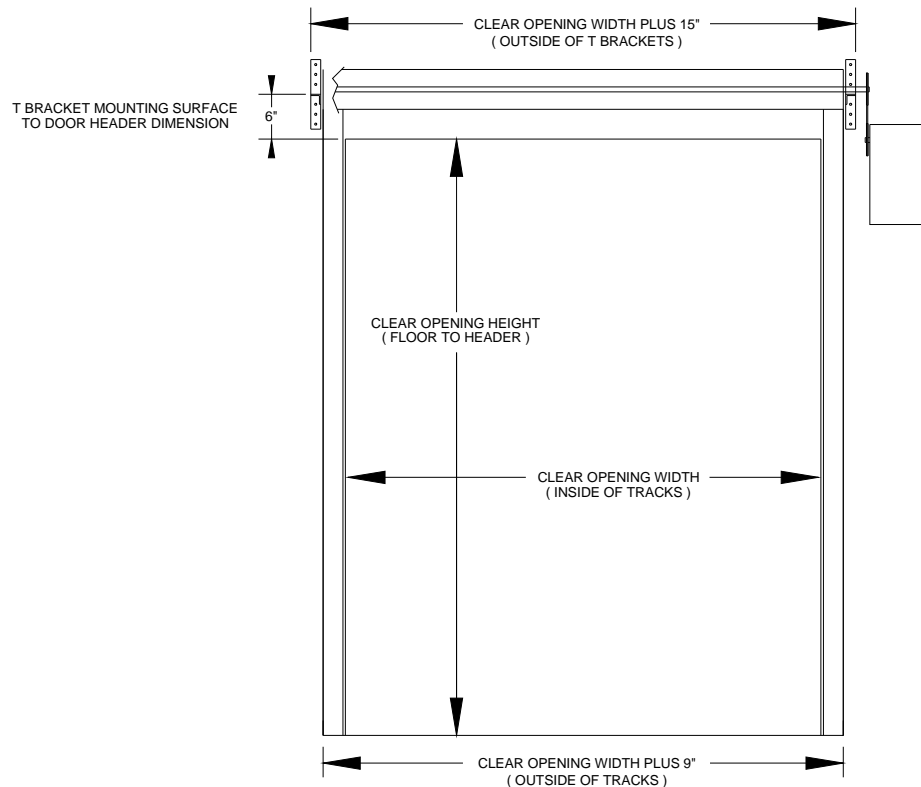

Door dimension drawing

DuraShield Installation Manual

Motorized – Inside Standoff

2. T Bracket Installation

refer to **Door Mounting and Dimension Drawings on page 2 & 3**

Referring to the door size and following drawing, locate and mount the T Brackets using appropriate fasteners for the wall surface. The T Bracket bearing mounting surface should be located to be at minimum 6" above the door header as shown. The inside mounting dimension of the T Brackets is Clear Opening Width + 11 inches, centered on the opening.

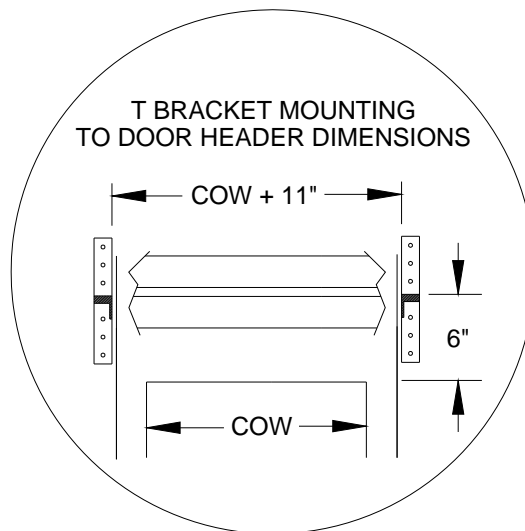

Right side shown, Left side opposite

DuraShield Installation Manual

Motorized – Inside Standoff

3. Roll Installation - NOTE: If you have a Roll Cover with Roll Cover Brackets provided see section 10 for installation before installing the Roll

Lift the roll into position. On the drive side, locate the pillow block onto the T Bracket and install the Bearing block to T bracket bolts. On the non drive side, either locate the pillow block to the T Bracket and install the T Bracket bolts or, for rolls supplied with a balancing spring, slide the Shaft Retainer Bracket onto the shaft and install the T Bracket bolts. Align the shaft keyway as shown with the locking allen screw and tighten the locking screw securely.

Be sure the curtain is coming off the back of the roll.



Standard Pillow Block Bearing



Shaft Retainer Bracket used with Balancing Spring

Adjust the roll to wall dimension for both T Brackets as shown below and tighten the Bearing and Retainer bolts.

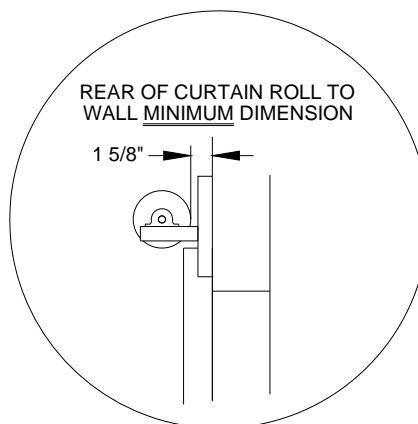

DuraShield Installation Manual

Motorized – Inside Standoff

4. Installing the Motorized Operator

WEIGHTS AND DIMENSIONS

HANGING WEIGHT: 60-70 LBS. (27.22-31.75 kg)

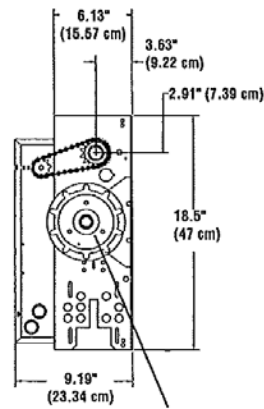
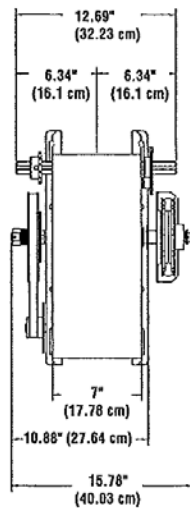

MOUNTING DIMENSIONS

- A - Wall Mounting
- B - Bracket Mounting (rolling door)

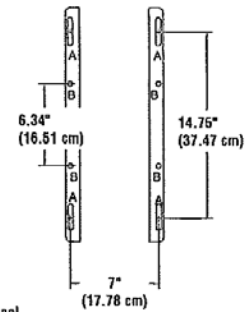

Hand Chain Wheel present with model MH only.

1 INSTALL OPERATOR DRIVE SPROCKET

Right hand assembly

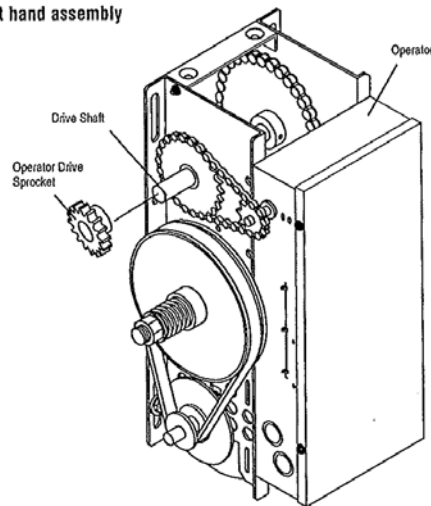

Left hand assembly

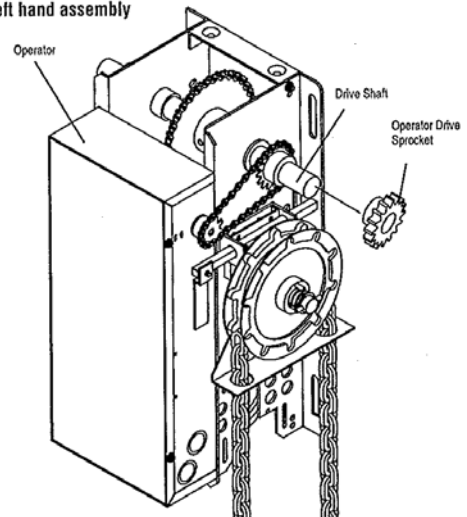

DuraShield Installation Manual

Motorized – Inside Standoff

1 DETERMINE MOUNTING LOCATION FOR OPERATOR

The operator may be mounted on the wall, shelf or bracket (not provided, see accessories or door manufacturer). The optimum distance between the door shaft and operator drive shaft is 12"-15".

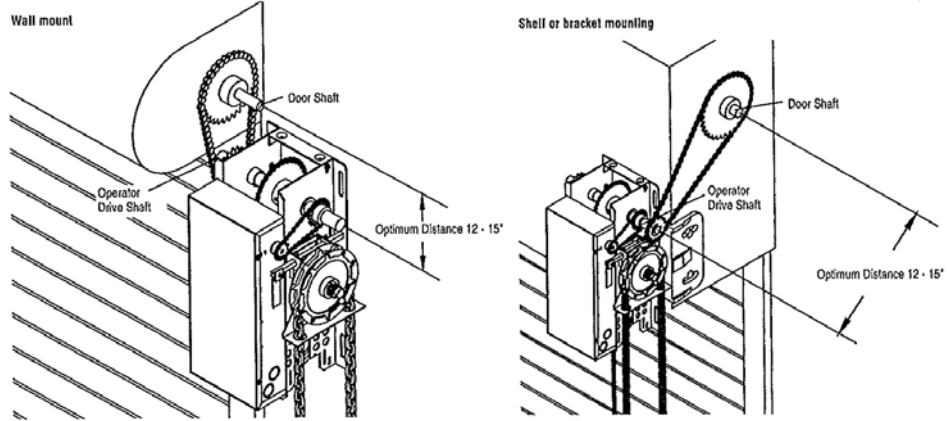

NOTE: All illustrations will depict a typical right hand wall mount installation.

2 PLACE DOOR SPROCKET ON DOOR SHAFT

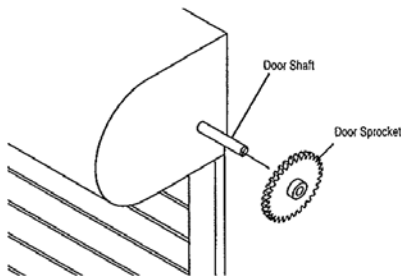

3 PLACE OPERATOR DOOR SPROCKET ON OPERATOR

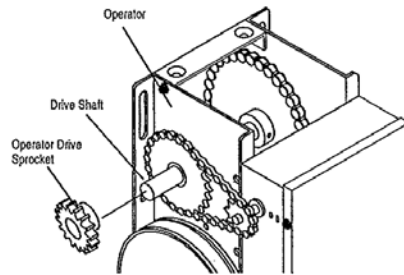

4 WRAP DRIVE CHAIN AROUND DOOR SPROCKET

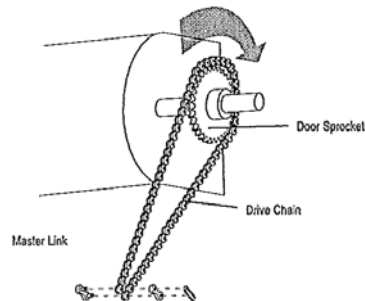

5 WRAP DRIVE CHAIN AROUND OPERATOR SPROCKET

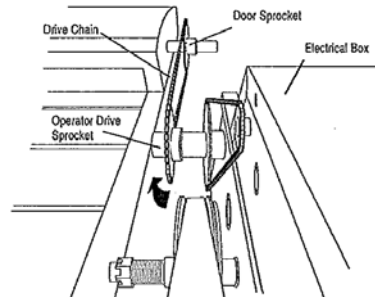

DuraShield Installation Manual

Motorized – Inside Standoff

6 POSITION OPERATOR

Adjust operator until chain is taut (not tight). If chain is too tight, it may cause damage to operator.

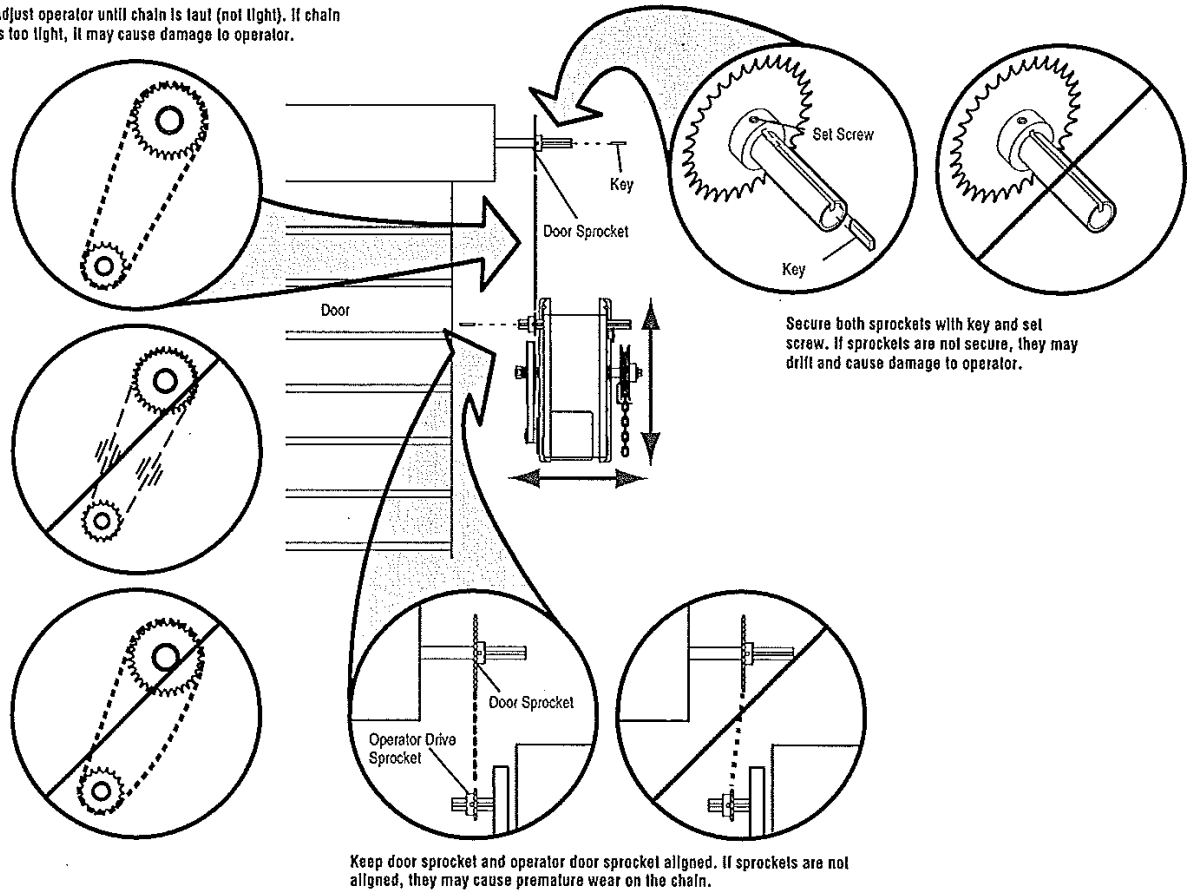

5. For Connection of and Programming of Operator - refer to instructions provided with the operator

At this time refer to the operator installation manual and make the power and wiring connections. Refer to your door order to determine the correct voltage for the supplied operator and for the optional activators that may have been provided with your door. Adjustment of the Limit switches and Clutch will be done after installation of the Guide Tracks.

DuraShield Installation Manual

Motorized – Inside Standoff

6. Installation of Guide Tracks - refer to Door Mounting and Dimension Drawings on page 2 & 3

Measure the Guide Tracks provided as they may need to be cut on site during installation. Be sure to cut the bottom of the track if needed. The top of the guide tracks should be 2 inches minimum to 3 inches maximum from the fully opened curtain roll.

The Guide Tracks are slotted on one end. This is the top. The rear of the Guide Track should be flat against the wall surface and are mounted to the wall using Guide Track L Brackets at top and bottom of the track and using a two foot spacing between. Tracks are mounted to the floor using two Guide Track L Brackets if desired.

The slotted tabs on the top of the track are bent outward at an angle. Bend the rear until it reaches the wall and bend the front to approximately the same angle. Insert the end of the curtain into the track.



Extended Guide Track Mounting Bracket



Top Track Adjustment

DuraShield Installation Manual

Motorized – Inside Standoff

7. Limit Switch and Clutch adjustment -

1 ADJUST THE LIMITS

WARNING

To avoid **SERIOUS** personal **INJURY** or **DEATH** from electrocution, disconnect electric power **BEFORE** moving limit nuts or adjusting clutch nut.

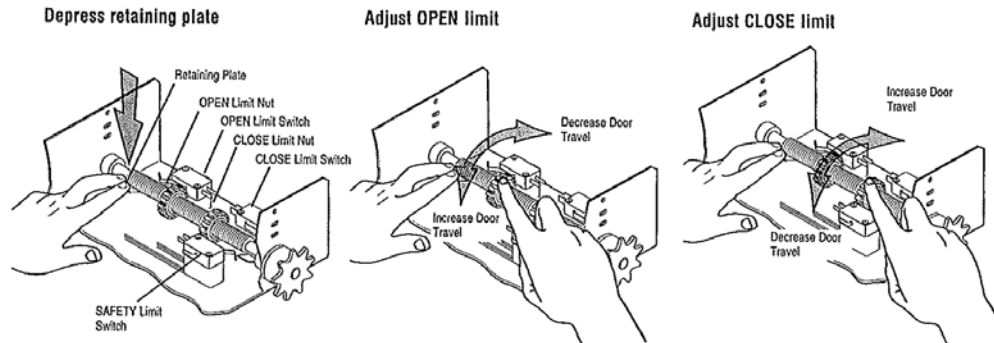

NOTE: When retaining plate is released, verify that the retaining plate is fully seated with the notches of the limit nut.

2 ADJUST THE CLUTCH

- Apply power to operator
- Turn clutch nut to release tension.
- Re-tighten nut until there is just enough tension to permit smooth operation.
- Secure clutch nut with cotter pin.

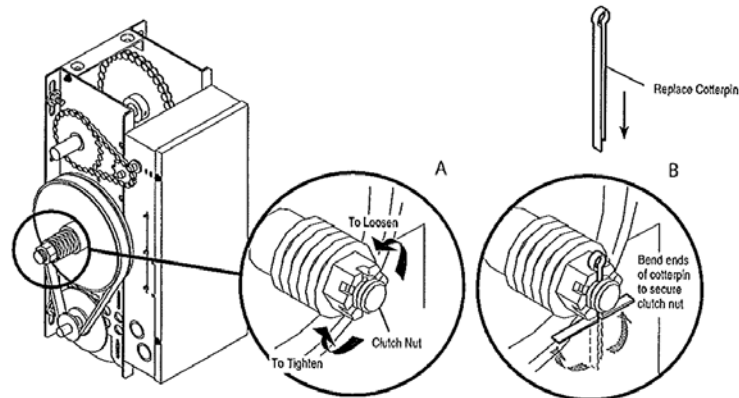

DuraShield Installation Manual

Motorized – Inside Standoff

8. Confirm adjustment of roll clearance in Guide Tracks -

Be sure that both ends of the roll on the T Brackets maintain entry of the curtain into the Guide Tracks at the curtain positions as shown below and to the minimum dimension shown on page 4. Fully tighten all roll mounting bolts. It could be necessary to drill additional holes in the T Brackets to properly adjust the roll to wall clearance.

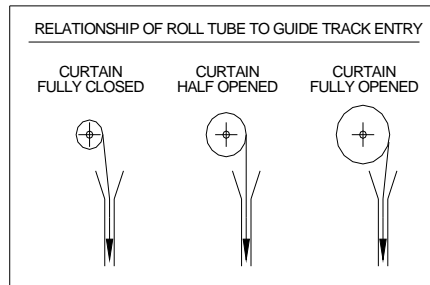

9. Installation of Optional Header Brush Seals -

Install the OPTIONAL curtain brush seal by attaching it to the bottom of the external door as shown. (fasteners not included) It can also mount to another surface as shown. The installer should determine an appropriate location. Be sure that the brush seal contacts the curtain when in the full closed position but does not press so hard to deform the curtain. Install the Top Side Brush Seals, the seals are field fit. Mark holes in seal mounting strip to mount on the (2) 3/8" L Bracket mounting bolts with provided fasteners as shown. The brush will contact the curtain and roll.

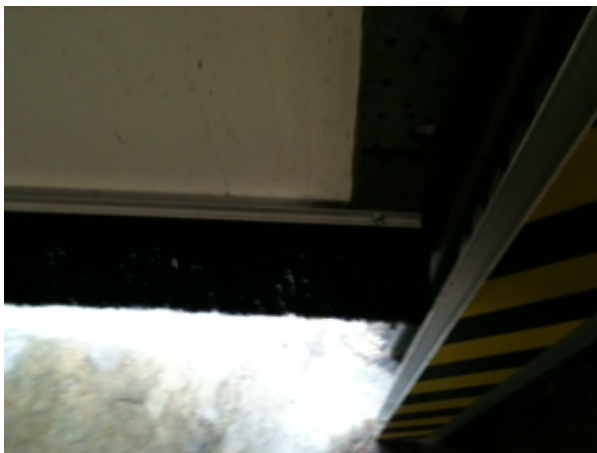

Brush seal mounted on bottom face of door



Top side brush seal and fasteners

DuraShield Installation Manual

Motorized – Inside Standoff

10. Installation of Optional Roll Cover -

Center the roll cover over the roll. Fasten securely to the wall.

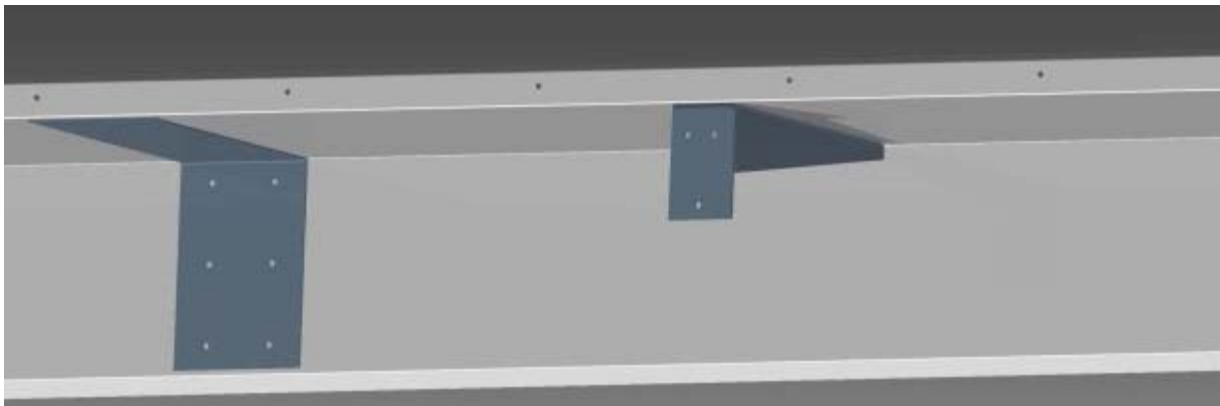

Splice Plate

Roll Cover Bracket

If your Roll Cover comes in multiple pieces a Splice Plate is provided, as shown, to connect the Roll Cover sections together. On wider Roll Covers, support brackets are provided as shown. The Roll Cover Brackets should be mounted to the wall to support the weight of the Roll Cover. They would be installed prior to installing the Roll as in section 3. They should be mounted so that the Roll Cover will be level when installed. They should be mounted near each end of the Roll Cover location and then spaced at approximately 24" apart. The Roll Cover is then lifted onto the installed support brackets and secured to the wall as normal. The Roll Cover does not attach to the support brackets, just to the wall. Any openings in the end caps, for shafts etc., are to be done by the installer on site.

DuraShield Installation Manual

Motorized – Inside Standoff

11. Final Assembly -

Go back and recheck all fasteners on the door assembly for tightness

Cycle the door and confirm correct opening and closing positions

Confirm operation of the door operator

Confirm curtain to guide track clearances per section 8. Be sure that guide tracks are clean and grease free inside and out.

Install Black Vinyl side panels (if supplied). These panels close in the gap between the Guide Track and the wall, see diagram on page 1. The side panel attaches to the Guide Track with installed Velcro and the installer attaches it to the wall in an appropriate manner.

Make sure end user is familiar with operation and has all manuals

DuraShield Installation Manual

Motorized – Inside Standoff